

Riverside County  
San Jacinto, California

**REGIONAL PARK ACCESSIBILITY  
IMPROVEMENT PROJECT  
(BID NO. 2020-120)**

**2020-2021**

**Contents:**

Specifications – Notice Inviting Bids – Bidding Requirements – Bid Forms –  
Contract Forms – Conditions of Contract

**Board of Directors:**

Nick Schouten, President  
John Bragg, Vice President  
Jan Bissell, Secretary  
Steve Simpson, Director  
Noah Rau, Director

**District Administration:**

Dean Wetter, General Manager  
James Salvador (Project Contact)  
Dusty Koelsch (Project Assistant)

## TABLE OF CONTENTS

<b><u>BIDDING REQUIREMENTS</u></b>	<b><u>PAGE</u></b>
Title Page	
Notice Inviting Bids	NIB-1 thru 3
Instructions to Bidders	B-1 thru B-8
Proposal Package Information Sheet <b>(READ THOROUGHLY)</b>	PP
Proposal (10 days)	C3-1
Bidding Sheets & Equipment & Material List	BS-1 thru BS-10
Bidder's Experience Record & Resumes	BR-1 thru BR-8
Designation of Subcontractors	C-5(a) thru C-5(e)
Public Works Contractors Registration Certification	C22-1
Contractor's Licensing Statement	C6-1
Non-Collusion Declaration	C7-1
Worker's Compensation Insurance Certificate	C11-1
Iran Contracting Act Certification	C13-1
Cal/OSHA Form 300A	C16-1 thru C16-2
Bid Bond	BB-1 thru BB-2
Performance Bond	C9-1 thru C9-4
Payment Bond	C10-1 thru C10-4
Contract	C8(a) thru C8(b)
Insurance Requirement Memorandum	C12-1
 <b><u>GENERAL CONDITIONS</u></b>	
Section F- Labor & Construction	F-1 thru F-56
Includes Exhibit A-Change Order Form	
 <b><u>SPECIAL CONDITIONS</u></b>	SC-1 thru SC-4
 <b><u>CONTRACT DRAWINGS</u></b>	
Regional Park Accessibility Improvement Plans	
Additional R/R Concrete Exhibit	
Valley-Wide Standard LC-02 and LC-03	

901 WEST ESPLANADE AVENUE  
P.O. BOX 907  
SAN JACINTO, CA 92582  
PHONE (951) 654-1505 · FAX (951) 654-5279

---

**Regional Park Accessibility Improvement Project**

**NOTICE INVITING BIDS**

**RECEIPT AND OPENING OF PROPOSALS:** Sealed bids will be received in the main office of the Valley-Wide Recreation & Park District ("District"), 901 West Esplanade Avenue, San Jacinto, CA 92582 until **Wednesday, July 8, 2020 at 2:00 p.m.** Bids received after this time will be returned unopened. Bids shall be valid for sixty (60) calendar days after the bid opening date. Bids must be submitted on the District's Bid Forms. No electronic bids or email bids will be accepted.

Due to COVID-19 the District is closed to public access; therefore, bids will not be publicly opened. The Preliminary Bid Summary will be posted on website <https://www.gorecreation.org/bids-and-documents> once all bids received have been opened.

**SCOPE OF WORK**

The work generally consists but not limited to the following:

- Removing existing concrete, asphalt, base, vegetation, signs and other items.
- Constructing concrete curb and gutter, sidewalk, and ADA ramps
- Signing and striping

**MANDATORY PRE-BID WALK-THRU**

Date: Thursday, June 25, 2020 at 10:00 a.m.

Location: Valley-Wide Regional Park  
South Parking Lot Near Sport Center  
901 W. Esplanade Ave  
San Jacinto, California 92582

All attendees are required to wear face masks / coverings and maintain a minimum of 6 feet distance from each other throughout the walk-thru. Limit one (1) attending representative per contracting company.

**QUESTIONS:** All questions must be submitted in writing by 2:00 p.m. on Tuesday, June 30, 2020, to Dusty Koelsch ([Dusty@GoRecreation.org](mailto:Dusty@GoRecreation.org)) and James Salvador ([JamesS@GoRecreation.org](mailto:JamesS@GoRecreation.org)). **Questions received after this time may not be responded to.**

**ENGINEERS ESTIMATE:** \$1,023,072.00

**COMPLETION OF WORK:** All work shall be complete within one hundred twenty (120) calendar days after receipt of Notice to Proceed. Liquidated damages of \$250.00 per calendar day will be assessed for exceeding any of the time completion requirements. Additional days will be given for days classified as “rain days” by the District Inspector.

**PLANS AND SPECIFICATIONS:** Copies of the Plans and Specifications are available electronically for inspection at no cost at [www.GoRecreation.org/bids-and-documents](http://www.GoRecreation.org/bids-and-documents). No bid sets will be available for purchase. Plans and Specifications are also available at the following planrooms: Bid America at [www.BidAmerica.com](http://www.BidAmerica.com) and AGC San Diego at [www.AGCSD.org](http://www.AGCSD.org).

**GUARANTEE:** Bids must be accompanied by cash, a certified or cashier’s check or a Bid Bond in favor of the Valley-Wide Recreation and Park District in an amount not less than ten percent (10%) of the submitted Total Bid Price, as a guarantee that the bidder will enter into the contract for the work, the full amount of such guarantee to be forfeited to the District should successful bidder fail to enter into said contract as set forth in Section 20160 et seq. of the Public Contract Code of the State of California.

**SECURITY:** Each bid shall be accompanied by the security referred to in the Contract Documents, the non-collusion affidavit, the list of proposed subcontractor, and all additional documentation required by the Instructions to Bidders. The successful bidder will be required to furnish the District with a Performance Bond equal to 100% of the successful bid, and Payment Bond equal to 100% of the successful bid, prior to execution of the Contract. All bonds are to be obtained from a surety that meets all the State of California bonding requirements, as defined in Code of Civil Procedure Section 995.120, and is admitted by the State of California. Pursuant of Public Contract Code Section 22300, the successful bidder may substitute certain securities for funds withheld by District to ensure his performance under the Contract.

**INSURANCE:** The successful bidder will also be required to furnish the District with an insurance policy as specified in the Specifications.

**PREVAILING WAGE RATES:** The Director of Industrial Relations (DIR) has determined the general prevailing rate per diem wages in the locality in which this work is to be performed for each craft or type of worker needed to execute the Contract which will be awarded to the successful bidder, copies of which are on file and will be made available to any interested party upon request at the main office or online at <http://www.dir.ca.gov/dlsr>. A copy of these rates shall be posted by the successful bidder at the job site. The successful bidder, and all subcontractor(s) under him, shall comply with all applicable Labor Code provisions, which include, but are not limited to the payment of not less than the required prevailing rates to all hours of labor and the debarment of contractors and subcontractors.

Pursuant to Labor Code sections 1725.5 and 1771.1, all contractors and subcontractors that wish to bid on, be listed in a bid proposal, or enter into a contract to perform public work must be registered with the Department of Industrial Relations. No Bid will be accepted nor any contract entered into without proof of the contractor’s and subcontractors’ current registration with the Department of Industrial Relations to perform public work. If awarded a contract, the Bidder and its subcontractors, of any tier, shall maintain active registration with the Department of Industrial Relations for the duration of the Project.

**CONTRACT TIME:** No bid or bid security may be withdrawn for seventy-five (75) calendar days after the date bids are received. The successful bidder shall within fifteen (15) calendar days after the District mails a Notice of Acceptance of bid, return the signed contract and bonds, and attend the pre-construction conference at the District's Administration office. The contract period shall commence fifteen (15) calendar days from the date of the Notice-of-Acceptance-of-Proposal / Notice to Proceed. The Contractor shall complete all work including testing, within ninety (90) Calendar days.

**REQUIRED CONTRACTOR LICENSE:** Bidders on this work will be required to be licensed by the State of California as **Class A General Contractor or Class B General Building** at the time of the bid and at the time of award as such license is defined in Section 7056 and/or Section 7058 of the Business and Professional Code and Section 732 of the California Administrative Code.

**AWARD OF CONTRACT:** The District shall award the Contract for the Project to the lowest responsible bidder as determined from the base bid alone by the District. The District reserves the right to reject any or all bids or to waive an irregularities or information in any bids or in the bidding process.

**CERTIFIED PAYROLL:** The winning bid contractor will be required to concurrently submit weekly certified payroll to the Department of Industrial Relations when submitting their monthly invoice payment request to Valley-Wide Recreation and Park District. The District's invoice payment policy is thirty (30) days.

**ADDITIONAL INFORMATION:** All inquiries shall be directed to James Salvador at [JamesS@GoRecreation.org](mailto:JamesS@GoRecreation.org) or at (951) 654-1505.

Dated this 2 day of June, 2020



-----  
Dean Wetter, General Manager  
Valley-Wide Recreation & Park District

Posted date: June 5, 2020

## INSTRUCTIONS TO BIDDERS

### **B-01. SECURING DOCUMENTS**

Bids must be submitted to the District on the Bid Forms which are a part of the Bid Package for the Project. Bid and Contract Documents may be obtained ~~from the Administration Office at: 901 W. Esplanade Avenue, San Jacinto California, 92582~~ or [www.GoRecreation.org/bids-and-documents](http://www.GoRecreation.org/bids-and-documents), any time after **June 5, 2020**. Prospective bidders are encouraged to telephone in advance to determine the availability of Contract Documents. Any charge for the Contract Documents is stated in the Notice Inviting Bids.

The District may also make the Contract Documents available for review at one or more plan rooms, as indicated in the Notice Inviting Bids. Please Note: Prospective Bidders who choose to review the Contract Documents at a plan room must contact the District to obtain the required Contract Documents if they decide to submit a bid for the Project.

Any Addenda will be posted on [www.GoRecreation.org/bids-and-documents](http://www.GoRecreation.org/bids-and-documents). Failure to acknowledge addenda may make a bid nonresponsive and not eligible for award of the contract.

### **B-02. EXAMINATION OF SITE AND CONTRACT DOCUMENTS**

At its own expense and prior to submitting its Bid, each Bidder shall visit the site of the proposed work and fully acquaint itself with the conditions relating to the construction and labor required so that the Bidder may fully understand the work, including but not limited to difficulties and restrictions attending the execution of the work under the contract. Each Bidder shall carefully examine the Drawings, and shall read the Specifications, Contract, and all other documents referenced herein. Each Bidder shall also determine the local conditions which may in any way affect the performance of the work, including local tax structure, contractors' licensing requirements, availability of required insurance, the prevailing wages and other relevant cost factors, shall familiarize itself with all federal, state and local laws, ordinances, rules, regulations and codes affecting the performance of the work, including the cost of permits and licenses required for the work, and shall make such surveys and investigations, including investigations of subsurface or latent physical conditions at the site or where work is to be performed as may be required. Bidders are responsible for consulting the standards referenced in the Contract. The failure or omission of any Bidder to receive or examine any contract documents, forms, instruments, addenda, or other documents, or to visit the site and acquaint itself with conditions there existing shall in no way relieve any Bidder from any obligation with respect to its Bid or to the contract and no relief for error or omission will be given except as required under State law. The submission of a Bid shall be taken as conclusive evidence of compliance with this Article.

### **B-03. INTERPRETATION OF DRAWINGS AND DOCUMENTS**

Prospective Bidders unclear as to the true meaning of any part of the Drawings, Specifications or other proposed contract documents may submit to the Engineer of the District a written request for interpretation. The prospective Bidder submitting the request is responsible for prompt delivery. Interpretation of the Drawings, Specifications or other proposed contract documents will be made only by a written addendum duly issued and a copy of such addenda will be mailed or delivered to each prospective Bidder who has purchased a set of Drawings and Specifications. The District will not be responsible for any other explanation or interpretations of the proposed documents. If a Prospective Bidders becomes aware of any errors or omissions in any part of the Contract Documents, it is the obligation of the Prospective Bidder to promptly bring it to the attention of the District.

#### **B-04. PRE-BID WALK-THRU**

A Mandatory Pre-Bid Walk-Thru is scheduled for **Thursday, June 25, 2020 at 10:00 a.m.** to review the Project's existing conditions at the Valley-Wide Regional Park, 901 W. Esplanade Ave, San Jacinto, CA 92582. Representatives of the District and consulting engineers, if any, will be present. Questions asked by Bidders at the Pre-Bid Walk-Thru not specifically addressed within the Contract Documents shall be answered in writing, and shall be sent to all Bidders present at the Pre-Bid Walk-Thru. **Bids will not be accepted from any bidder who did not attend the Mandatory Pre-Bid Walk-Thru.**

#### **B-05. ADDENDA**

The District reserves the right to revise the Contract Documents prior to the Bid opening date. Revisions, if any, shall be made by written Addenda. All Addenda issued by the District shall be included in the Bid and made part of the Contract Documents. Pursuant to Public Contract Code Section 4104.5, if the District issues an Addendum which includes material changes to the Project less than 72 hours prior to the deadline for submission of Bids, the District will extend the deadline for submission of Bids. The District may determine, in its sole discretion, whether an Addendum warrants postponement of the Bid submission date. Each prospective Bidder shall provide District a name, address, email address, and facsimile number to which Addenda may be sent, as well as a telephone number by which the District can contact the Bidder. Copies of Addenda will be furnished by email, facsimile, first class mail, express mail or other proper means of delivery without charge to all parties who have obtained a copy of the Contract Documents and provided such current information. Please Note: Bidders are responsible for ensuring that they have received any and all Addenda. To this end, each Bidder should contact the Valley-Wide Administration office at (951) 654-1505, or at [www.GoRecreation.org/bids-and-documents](http://www.GoRecreation.org/bids-and-documents), to verify that it has received all Addenda issued, if any, prior to the Bid opening. The Bidder shall indicate the Addenda received prior to bidding in the space provided in the Bid Form. Failure to indicate all Addenda may be sufficient cause for rejecting the Bid.

#### **B-06. ALTERNATE BIDS**

If alternate bid items are called for in the Contract Documents, the time required for completion of the alternate bid items has already been factored into the Contract duration and no additional Contract time will be awarded for any of the alternate bid items. The District may elect to include one or more of the alternate bid items, or to otherwise remove certain work from the Project scope of work. Accordingly, each bidder must ensure that each bid item contains a proportionate share of profit, overhead, and other costs or expenses which will be incurred by the bidder.

#### **B-07. COMPLETION OF BID FORMS**

Bids shall only be prepared using copies of the Bid Forms which are included in the Contract Documents. The use of substitute Bid Forms other than clear and correct photocopies of those provided by the District will not be permitted. Bids shall be executed by an authorized signatory as described in these Instructions to Bidders. In addition, Bidders shall fill in all blank spaces (including inserting "N/A" where applicable), and initial all interlineations, alterations, or erasures to the Bid Forms. Bidders shall neither delete, modify, nor supplement the printed matter on the Bid Forms nor make substitutions thereon. **USE OF BLACK OR BLUE INK, INDELIBLE PENCIL, OR A TYPEWRITER IS REQUIRED.** Deviations in the Bid Forms may result in the Bid being deemed non-responsive.

**B-08. MODIFICATIONS OF BIDS**

Each Bidder shall submit its Bid in strict conformity with the requirements of the Contract Documents. Unauthorized additions, modifications, revisions, conditions, limitations, exclusions or provisions attached to a Bid may render it non-responsive and may cause its rejection. Bidders shall not delete, modify, or supplement the printed matter on the Bid Forms, or make substitutions thereon. Oral, telephonic and electronic modifications will not be considered.

**B-09. SUBCONTRACTORS**

Bidder shall set forth the name, address of the place of business, and contractor license number of each subcontractor who will perform work, labor, furnish materials or render services to the bidder on said contract and each subcontractor licensed by the State of California who, under subcontract to bidder, specially fabricates and installs a portion of the Work described in the Drawings and Specifications in an amount in excess of one half of one percent (0.5%) of the total bid price, and shall indicate the portion of the work to be done by such subcontractor in accordance with Public Contract Code Section 4104.

**B-10. LICENSING REQUIREMENTS**

Pursuant to Business and Professions Code Section 7028.15 and Public Contract Code Section 3300, all bidders must possess proper licenses for performance of this Contract. Subcontractors must possess the appropriate licenses for each specialty subcontracted. Pursuant to Business and Professions Code Section 7028.5, the District shall consider any bid submitted by a contractor not currently licensed in accordance with state law and pursuant to the requirements found in the Contract Documents to be nonresponsive, and the District shall reject the Bid. The District shall have the right to request, and Bidders shall provide within ten (10) calendar days, evidence satisfactory to the District of all valid license(s) currently held by that Bidder and each of the Bidder's subcontractors, before awarding the Contract.

Notwithstanding anything contained herein, if the Work involves federal funds, the Contractor shall be properly licensed by the time the Contract is awarded, pursuant to the provisions of Public Contract Code section 20103.5.

**B-11. BID GUARANTEE (BOND)**

Each bid shall be accompanied by: (a) cash; (b) a certified or cashier's check made payable to Valley-Wide Recreation and Park District; or (c) a Bid Bond secured from a surety company satisfactory to the District, the amount of which shall not be less than ten percent (10%) of the Total Bid Price, made payable to Valley-Wide Recreation and Park District as bid security. Personal sureties and unregistered surety companies are unacceptable. The surety insurer shall be California admitted surety insurer, as defined in Code of Civil Procedure Section 995.120. The bid security shall be provided as a guarantee that within ten (10) working days after the District provides the successful bidder the Notice of Award, the successful bidder will enter into a contract and provide the necessary bonds and certificates of insurance. The bid security will be declared forfeited if the successful bidder fails to comply within said time, and District may enter into a contract with the next lowest responsive responsible bidder, or may call for new bids. No interest shall be paid on funds deposited with the District. District will return the security accompanying the bids of all unsuccessful bidders no later than 60 calendar days after award of the contract.

**B-12. IRAN CONTRACTING ACT OF 2010**

In accordance with Public Contract Code Section 2200 *et seq.*, the District requires that any person that submits a bid or proposal or otherwise proposes to enter into or renew a contract with the District with respect to goods or services of one million dollars (\$1,000,000) or more,



certify at the time the bid is submitted or the contract is renewed, that the person is not identified on a list created pursuant to subdivision (b) of Public Contract Code Section 2203 as a person engaging in investment activities in Iran described in subdivision (a) of Public Contract Code Section 2202.5, or as a person described in subdivision (b) of Public Contract Code Section 2202.5, as applicable.

The form of such Iran Contracting Certificate is included with the bid package and must be signed and dated under penalty of perjury.

**B-13. NON-COLLUSION DECLARATION**

Bidders on all public works contracts are required to submit a declaration of non-collusion with their bid. This form is included with the bid package and must be signed and dated under penalty of perjury.

**B-14. PUBLIC WORKS CONTRACTOR REGISTRATION CERTIFICATION**

Pursuant to Labor Code sections 1725.5 and 1771.1, all contractors and subcontractors that wish to bid on, be listed in a bid proposal, or enter into a contract to perform public work must be registered with the Department of Industrial Relations. No bid will be accepted nor any contract entered into without proof of the contractor's and subcontractors' current registration with the Department of Industrial Relations to perform public work. If awarded a contract, the bidder and its subcontractors, of any tier, shall maintain active registration with the Department of Industrial Relations for the duration of the Project. To this end, Bidder shall sign and submit with its Bid the Public Works Contractor Registration Certification on the form provided, attesting to the facts contained therein. Failure to submit this form may render the bid non-responsive. In addition, each Bidder shall provide the registration number for each listed subcontractor in the space provided in the Designation of Subcontractors form.

**B-15. BIDDER INFORMATION AND EXPERIENCE FORM**

Each Bidder shall complete the questionnaire provided herein and shall submit the questionnaire along with its Bid. Failure to provide all information requested within the questionnaire along with the Bid may cause the bid to be rejected as non-responsive. The District reserves the right to reject any Bid if an investigation of the information submitted does not satisfy the Engineer that the Bidder is qualified to properly carry out the terms of the contract.

**B-16. WORKERS' COMPENSATION CERTIFICATION**

In accordance with the provisions of Labor Code Section 3700, Contractor shall secure the payment of compensation to its employees. Contractor shall sign and file with the District the following certificate prior to performing the work under this Contract:

I am aware of the provisions of Section 3700 of the Labor Code, which require every employer to be insured against liability for workers' compensation or to undertake self-insurance in accordance with the provisions of that code, and I will comply with such provisions before commencing the performance of the work of this contract.

The form of such Workers' Compensation Certificate is included as part of this document.

**B-17. SIGNING OF BIDS**

All Bids submitted shall be executed by the Bidder or its authorized representative. Bidders may be asked to provide evidence in the form of an authenticated resolution of its Board of Directors or a Power of Attorney evidencing the capacity of the person signing the Bid to bind

the Bidder to each Bid and to any Contract arising therefrom.

If a Bidder is a joint venture or partnership, it may be asked to submit an authenticated Power of Attorney executed by each joint venturer or partner appointing and designating one of the joint venturers or partners as a management sponsor to execute the Bid on behalf of Bidder. Only that joint venturer or partner shall execute the Bid. The Power of Attorney shall also: (1) authorize that particular joint venturer or partner to act for and bind Bidder in all matters relating to the Bid; and (2) provide that each venturer or partner shall be jointly and severally liable for any and all of the duties and obligations of Bidder assumed under the Bid and under any Contract arising therefrom. The Bid shall be executed by the designated joint venturer or partner on behalf of the joint venture or partnership in its legal name.

**B-18. SUBMISSION OF SEALED BIDS**

Once the Bid and supporting documents have been completed and signed as set forth herein, they shall be placed, along with the Bid Guarantee and other required materials, in a sealed envelope, addressed and delivered or mailed, postage prepaid, to the Engineering Department of the District before the time and day set for the receipt of bids. The envelope shall bear the title of the work and the name of the bidder. No oral or telephonic bids will be considered. No forms transmitted via the internet, e-mail, facsimile, or any other electronic means will be considered unless specifically authorized by the District as provided herein. Bids received after the time and day set for the receipt of bids shall be returned to the bidder unopened. The envelope shall also contain the following in the lower left-hand corner thereof:

**Bid of \_\_\_\_\_ (Bidder's Name)**  
**for the \_\_\_\_\_ Regional Park Accessibility Improvement Project**

Only where expressly permitted in the Notice Inviting Bids may bidders submit their bids via electronic transmission pursuant to Public Contract Code sections 1600 and 1601. Any acceptable method(s) of electronic transmission shall be stated in the Notice Inviting Bids. District may reject any bid not strictly complying with District's designated methods for delivery.

**B-19. OPENING OF BIDS**

At the time and place set for the opening and reading of bids, or any time thereafter, each and every bid received prior to the time and day set for the receipt of bids will be publicly opened and read. The District will leave unopened any Bid received after the specified date and time, and any such unopened Bid will be returned to the bidder. It is the bidder's sole responsibility to ensure that its Bid is received as specified. Bids may be submitted earlier than the date(s) and time(s) indicated.

The public reading of each bid will include the following information:

- A. The name and business location of the bidder.
- B. The nature and amount of the bid security furnished by bidder.
- C. The bid amount.

Bidders or their representatives and other interested persons may be present at the opening of the bids. The District may, in its sole discretion, elect to postpone the opening of the submitted Bids. The District reserves the right to reject any or all Bids and to waive any informality or irregularity in any Bid.

**B-20. WITHDRAWAL OF BID**

Any bid may be withdrawn either personally or by written request, incurring no penalty, at any time prior to the scheduled closing time for receipt of bids. Requests to withdraw bids shall be worded so as not to reveal the amount of the original bid. Withdrawn bids may be resubmitted until the time and day set for the receipt of bids, provided that resubmitted bids are in conformance with the instructions herein.

Bids may be withdrawn after bid opening only by providing written notice to District within five (5) working days of the bid opening and in compliance with Public Contract Code Section 5100 *et seq.*, or as otherwise may be allowed with the consent of the District.

**B-21. BIDDERS INTERESTED IN MORE THAN ONE BID**

No Bidder shall be allowed to make, file or be interested in more than one bid for the same work unless alternate bids are specifically called for. A person, firm or corporation that has submitted a sub-proposal to a Bidder, or that has quoted prices of materials to a Bidder, is not thereby disqualified from submitting a sub-proposal or quoting prices to other bidders. No person, firm, corporation, or other entity may submit a sub-proposal to a Bidder, or quote prices of materials to a Bidder, when also submitting a prime Bid on the same Project.

**B-22. SUBSTITUTION OF SECURITY**

The Contract Documents call for monthly progress payments based upon the percentage of the Work completed. The District will retain a percentage of each progress payment as provided by the Contract Documents. At the request and expense of the successful Bidder, the District will substitute securities for the amount so retained in accordance with Public Contract Code Section 22300.

**B-23. PREVAILING WAGES**

The District has obtained from the Director of the Department of Industrial Relations the general prevailing rate of per diem wages in the locality in which this work is to be performed for each craft or type of worker needed to execute the Contract. These rates may be obtained online at <http://www.dir.ca.gov> or are available at the Valley-Wide Administration office at 901 W. Esplanade Avenue, San Jacinto, CA. Bidders are advised that a copy of these rates must be posted by the successful Bidder at the job site(s).

**B-24. DEBARMENT OF CONTRACTORS AND SUBCONTRACTORS**

In accordance with the provisions of the Labor Code, contractors or subcontractors may not perform work on a public works project with a subcontractor who is ineligible to perform work on a public project pursuant to Labor Code Sections 1777.1 or 1777.7. Any contract on a public works project entered into between a contractor and a debarred subcontractor is void as a matter of law. A debarred subcontractor may not receive any public money for performing work as a subcontractor on a public works contract. Any public money that is paid to a debarred subcontractor by the Contractor for the Project shall be returned to the District. The Contractor shall be responsible for the payment of wages to workers of a debarred subcontractor who has been allowed to work on the Project.

**B-25. INSURANCE REQUIREMENTS**

Prior to commencing work, the successful bidder shall purchase and maintain insurance as set forth in the General Conditions.

**B-26. PERFORMANCE BOND AND PAYMENT BOND REQUIREMENTS**

The successful bidder will be required to furnish a Labor and Material Payment Bond and a

Faithful Performance Bond each in an amount equal to one hundred percent (100%) of the contract price. Each bond shall be secured from a surety company that meets all State of California bonding requirements, as defined in California Code of Civil Procedure Section 995.120 and is admitted by the State of California. Each bond shall be accompanied, upon the request of District, with all documents required by California Code of Civil Procedure Section 995.660 to the extent required by law. All bonding and insurance requirements shall be completed and submitted to District within ten (10) working days from the date the District provides the successful bidder with the Notice of Award.

**B-27. SALES AND OTHER APPLICABLE TAXES, PERMITS, LICENSES AND FEES**

Contractor and its subcontractors performing work under this Contract will be required to pay California sales tax and other applicable taxes, and to pay for permits, licenses and fees required by the agencies with authority in the jurisdiction in which the Work will be located, unless otherwise expressly provided by the Contract Documents.

**B-28. PERMIT AND INSPECTION FEE ALLOWANCE**

Notwithstanding anything contained herein, the Bid Form contains an allowance for the Contractor's cost of acquiring traffic control permits and for construction inspection fees that may be charged to the Contractor by the Agency of Jurisdiction. The allowance is included within the Bid Form to eliminate the need by bidders to research or estimate the costs of traffic control permits and construction inspection fees prior to submitting a bid. The allowance is specifically intended to account for the costs of traffic control permits and construction inspection fees charged by the local Agency of Jurisdiction only. No other costs payable by Contractor to the Agency of Jurisdiction are included within the allowance.

**B-29. FILING OF BID PROTESTS**

Bidders may file a "protest" of a Bid with the District's General Manager. In order for a Bidder's protest to be considered valid, the protest must:

- D. Be filed in writing within five (5) calendar days after the bid opening date;
- E. Clearly identify the specific irregularity or accusation;
- F. Clearly identify the specific District staff determination or recommendation being protested;
- G. Specify in detail the grounds for protest and the facts supporting the protest; and
- H. Include all relevant, supporting documentation with the protest at time of filing.

If the protest does not comply with each of these requirements, the District may reject the protest without further review.

If the protest is timely and complies with the above requirements, the District's General Manager, or other designated District staff member, shall review the protest, any response from the challenged Bidder(s), and all other relevant information. The General Manager will provide a written decision to the protestor.

The procedure and time limits set forth in this Article are mandatory and are the sole and exclusive remedy in the event of a Bid protest. Failure to comply with these procedures shall constitute a failure to exhaust administrative remedies and a waiver of any right to further

pursue the Bid protest, including filing a Government Code Claim or legal proceedings.

**B-30. BASIS OF AWARD; BALANCED BID**

The District shall award the Contract to the lowest responsible Bidder submitting a responsive Bid. The lowest Bid will be determined on the basis of the Total Bid Price. The District may reject any Bid which, in its opinion when compared to other Bids received or to the District's internal estimates, does not accurately reflect the cost to perform the Work. The District may reject as non-responsive any Bid which unevenly weights or allocates costs, including but not limited to overhead and profit to one or more particular bid items.

**B-31. AWARD PROCESS**

Once all Bids are opened and reviewed to determine the lowest responsive and responsible Bidder, the District Board may award the contract. The apparent successful Bidder should begin to prepare the following documents: (1) the Performance Bond; (2) the Payment Bond; and (3) the required insurance certificates and endorsements. Once the District notifies the Bidder of the award, the Bidder will have ten (10) working days from the date of this notification to execute the Contract and supply the District with all of the required documents and certifications. Regardless of whether the Bidder supplies the required documents and certifications in a timely manner, the Contract time will begin to run twenty (20) working days from the date of the notification. Once the District receives all of the properly drafted and executed documents and certifications from the Bidder, the District shall issue a Notice to Proceed to that Bidder.

**B-32. EXECUTION OF CONTRACT**

As required herein the Bidder to whom an award is made shall execute the Contract in the amount determined by the Contract Documents. The District may require appropriate evidence that the persons executing the Contract are duly empowered to do so. The Contract and bond forms to be executed by the successful Bidder are included within these Specifications and shall not be detached.

**B-33. QUESTIONS**

Questions regarding this Notice Inviting Bids may be directed to James Salvador, at (951) 654-1505 or email at [JamesS@GoRecreation.org](mailto:JamesS@GoRecreation.org). No other members of the District's staff or District Board should be contacted about this procurement during the bidding process. Any and all inquiries and comments regarding this Bid must be communicated in writing, unless otherwise instructed by the District. The District may, in its sole discretion, disqualify any Bidder who engages in any prohibited communications.

## PROPOSAL PACKAGE INFORMATION SHEET

PROJECT NAME: Regional Park Accessibility Improvement Project (Bid No. 2020-120)

**NOTICE TO BIDDER:** The attached Proposal Package, when complete by you and returned to this District, constitutes your Bid on this project. **Please do not submit the bound copy of the specifications or addenda with your Bid.**

The envelope enclosing the proposal **MUST** be sealed and addressed as follow:

**Regular, Express Mail, FedEx or Hand-Deliver**

Valley-Wide Recreation and Park District  
Attention: James Salvador  
901 W. Esplanade Avenue  
San Jacinto, CA 92581

The envelope **MUST** be plainly marked in the upper left hand corner with the name and address of the bidder, and bear the words:

**Proposal for:**  
**(Project Name)**  
**(Date and Hour)**

### **SIGN, COMPLETE, AND SUBMIT THE FOLLOWING:**

- Proposal Sheet (C3-1) **Signature required!**
- Bidding Sheets & Equipment and Material List – (BS-1 thru 10)
- Bidder's Experience Record & Resumes of Key Personnel (BR-1 thru 8)
- Subcontractors List (C-5(d) thru (e))
- Public Works Contractor Registration Certification (C22-1)
- Contractor's Licensing Statement (C6-1)
- Non-collusion Declaration (C7-1)
- Workers' Compensation Insurance Certificate (C11-1)
- Iran Contracting Act Certification (C13-1) **(only required if bid is over \$1 million)**
- Cal/OSHA Form 300A (C16-1 thru 2)
- Bid Guarantee (per Notice Inviting Bids and Instructions to Bidders)

**If Bid Bond, must be signed By You and Your Surety Company-Surety Acknowledgement required. Notary Acknowledgement required or Surety and Contractor**

**PLEASE COMPLETE AND SIGN ALL REQUIRED AREAS. SUBMIT AND ATTACH ANY ADDITIONAL DOCUMENTATION WHICH CONSTITUTES YOUR BID**

**FAILURE TO COMPLETE THIS PROPOSAL PACKAGE MAY RENDER YOUR BID "NON-RESPONSIVE"**

**\*Please Remove This Information Sheet Prior to Submitting Your Bid\***

**PROPOSAL**

The undersigned hereby declares, as Bidder, that the only persons or parties interested in this proposal as principals are those named herein; that no director or any other officer or employee of the Valley-Wide Recreation District is in any manner interested directly or indirectly in this proposal or in the profits to be derived from the contract proposed to be taken; that this bid is made without any connection with any person or persons making a bid for the same purpose; that the bid is in all respects fair and without collusion or fraud; that he has read the Notice Inviting Bids (or Bidding Information) and the Instructions to Bidders and agrees to all the stipulations contained herein; that he proposes and agrees that if his bid as submitted in the attached sheets, be accepted he will contract in the form so approved and furnish the items called for in accordance with the provisions of said approved form of Agreement and the Specifications and to deliver the same within the time stipulated therein; and that he will accept in full payment therefore the prices named in said Bid Sheet.

The Bidder further agrees, that upon receipt of written notice of acceptance of the proposal with 60 days after the day of opening bids (unless otherwise specified in the Notice Inviting Bids or Bidding information) he will execute and return the Contract in accordance with the proposal as accepted and furnish the required bond(s) within **ten (10)** days from the date of mailing the Notice of Acceptance of Proposal to him at his address given below, or within such time as allowed by Valley-Wide; and that upon his failure or refusal to do so within the said time, then the certified or cashier's check or bond accompanying this bid shall become the property of and be retained by Valley-Wide as liquidated damages for such failure or refusal, and shall be deposited with the Accountant of said Valley-Wide as monies belonging to Valley-Wide; provided, that if said Bidder shall execute the Contract and furnish the required bond within the time aforesaid, his check or bond shall be returned to him thereafter.

The Bidder further declares that the surety or sureties named in the attached sheet have agreed to furnish bond in form and amount set forth in the accompanying Notice Inviting Bids (or Bidding Information) and Article 11 of the Instructions to Bidders, in the event contract is awarded on basis of this proposal.

Company: \_\_\_\_\_

Address: \_\_\_\_\_ Date: \_\_\_\_\_

By: \_\_\_\_\_  
 (Print Name) Name should appear below (Signature of Owner or Officer required)

Name(s) of Member of Firm or Officer of Corporation Authorized to enter into a binding Contract:	Address (if different from above)

For further detail on this proposal, please contact:

Name:	Address:
Email Address:	Telephone:





**VALLEY-WIDE RECREATION**  
**REGIONAL PARK ACCESSIBILITY IMPROVEMENT PROJECT**  
**BIDDING SHEETS**

The Contractor shall construct the project under these Specifications all in conformance with the Contract Drawings listed in Section P and these Specifications

The District reserves the right to:

- A. Accept or reject any or all bids on this specification;
- B. Award Contract to the lowest qualified bidder, based on the total bid price;
- C. Waive any defects and informalities.

The District shall be the final authority with regard to whether a bid is responsive to the call for bids and to whether a bidder is a responsible bidder under the conditions of his bid, or for any reason.

The total contract price shall include all work, materials, and equipment needed to complete the project as defined in the General Conditions, Section F. The bidder shall include costs for such other items in the most appropriate category (bid item).

**VALLEY-WIDE RECREATION**  
**REGIONAL PARK ACCESSIBILITY IMPROVEMENT PROJECT**  
**BIDDING SHEETS**

ADDITION OR DEDUCTION: Provision is made here for the bidder to include an addition/deduction in their bid, if desired, to reflect any last minute adjustments in process. The addition/deduction, if made, will be proportionately applied to item(s) \_\_\_\_\_ (fill in) and reflected in the unit process for payment purposes. If the addition/deduction affects more than one bid item, the proportionate application of the addition/deduction shall be mutually agreed upon by the Contract and the District at the prejob.

Person who inspected site of the proposed work as an employee of your firm: **(Representative must have inspected the jobsite and be employee on the company's payroll to be considered a responsive bidder)**

\_\_\_\_\_  
(Name)

\_\_\_\_\_  
(Date of Inspection)

**VALLEY-WIDE RECREATION**

**REGIONAL PARK ACCESSIBILITY IMPROVEMENT PROJECT**

**BIDDING SHEETS**

<b>Bid Item</b>	<b>Aprox. Qty.</b>	<b>Unit</b>	<b>Description Unit Price Written in Words</b>	<b>Unit Price (Figures)</b>	<b>Total Amount (Figures)</b>
1	492	LF	Sawcut existing concrete.  _____ (words)	\$ _____	\$ _____
2	18,424	SF	Remove existing concrete.  _____ (words)	\$ _____	\$ _____
3	19,330	SF	Construct 4" thick concrete walkway per Riverside County Standard 401 and Valley-Wide Standards LC-02 and LC-03.  _____ (words)	\$ _____	\$ _____
4	240	LF	Slurry seal between concrete and pavement.  _____ (words)	\$ _____	\$ _____
5	268	SF	Construct ADA accessible ramp per Riverside County Standard 403, Case "A".  _____ (words)	\$ _____	\$ _____
6	397	LF	Remove existing concrete curb.  _____ (words)	\$ _____	\$ _____
7	237	LF	Sawcut existing AC pavement.  _____ (words)	\$ _____	\$ _____
8	22,476	SF	Remove existing AC pavement.  _____ (words)	\$ _____	\$ _____

**VALLEY-WIDE RECREATION**

**REGIONAL PARK ACCESSIBILITY IMPROVEMENT PROJECT**

**BIDDING SHEETS**

<b>Bid Item</b>	<b>Aprox. Qty.</b>	<b>Unit</b>	<b>Description Unit Price Written in Words</b>	<b>Unit Price (Figures)</b>	<b>Total Amount (Figures)</b>
9	1,612	SF	Install minimum 3" AC over 4" Class II Agg Base.  _____ (words)	\$ _____	\$ _____
10	1,704	SF	Construct 3.0' wide concrete ribbon gutter per detail.  _____ (words)	\$ _____	\$ _____
11	1	LS	Remove and replace existing parking lot striping.  _____ (words)	\$ _____	\$ _____
12	14	EA	Install ADA parking space signage per 2019 CBC Section 11B-502.6.  _____ (words)	\$ _____	\$ _____
13	42	LF	Join existing A.C. pavement per join detail.  _____ (words)	\$ _____	\$ _____
14	948	SF	Install truncated domes per 2019 CBC Section 11B-705.  _____ (words)	\$ _____	\$ _____
15	92	LF	Remove and replace existing chainlink fence.  _____ (words)	\$ _____	\$ _____
16	14	EA	Install Brooks Products 36" long concrete wheel stops.  _____ (words)	\$ _____	\$ _____
17	4	LF	Install concrete step per plan.  _____ (words)	\$ _____	\$ _____

**VALLEY-WIDE RECREATION**

**REGIONAL PARK ACCESSIBILITY IMPROVEMENT PROJECT**

**BIDDING SHEETS**

<b>Bid Item</b>	<b>Aprox. Qty.</b>	<b>Unit</b>	<b>Description Unit Price Written in Words</b>	<b>Unit Price (Figures)</b>	<b>Total Amount (Figures)</b>
18	325	SF	Remove existing pavement ramp.  _____ (words)	\$ _____	\$ _____
19	3,184	SF	Grind and overlay existing A.C., min. 0.15'.  _____ (words)	\$ _____	\$ _____
20	3	EA	Remove existing ADA parking space signs.  _____ (words)	\$ _____	\$ _____
21	680	SF	Construct ADA accessible ramp per Riverside County Standard, Case "B"  _____ (words)	\$ _____	\$ _____
22	9	LF	Install 6" thick, 2.0' high cut off wall.  _____ (words)	\$ _____	\$ _____
23	71	SF	Install rip rap, 50lb rock, min. 2' thick.  _____ (words)	\$ _____	\$ _____
24	23	LF	Install hand rail per 2019 CBC Section 11B-505.  _____ (words)	\$ _____	\$ _____
25	501	LF	Construct 6" thick, 2.0' high cut off wall.  _____ (words)	\$ _____	\$ _____
26	444	SF	Construct concrete access ramp.  _____ (words)	\$ _____	\$ _____
27	107	LF	Install 3" high wheel guide & hand rail per 2019 CBC Section 11B-505 and detail sheet 9.  _____ (words)	\$ _____	\$ _____

**VALLEY-WIDE RECREATION**

**REGIONAL PARK ACCESSIBILITY IMPROVEMENT PROJECT**

**BIDDING SHEETS**

<b>Bid Item</b>	<b>Aprox. Qty.</b>	<b>Unit</b>	<b>Description Unit Price Written in Words</b>	<b>Unit Price (Figures)</b>	<b>Total Amount (Figures)</b>
28	17	LF	Remove existing chainlink fence.  _____ (words)	\$ _____	\$ _____
29	6	EA	Install International Symbol of Accessible Route signs per 2019 CBC Figure 11B-703.7.2.1 and details sheet 9.  _____ (words)	\$ _____	\$ _____
30	1	EA	Remove existing box inlet.  _____ (words)	\$ _____	\$ _____
31	44	EA	Remove existing concrete wheel stops.  _____ (words)	\$ _____	\$ _____
32	1	EA	Relocate existing concrete wheel stops.  _____ (words)	\$ _____	\$ _____
33	90	SF	Construct concrete drive approach, 6" thick, X=3'  _____ (words)	\$ _____	\$ _____
34	8	LF	Construct under sidewalk drain per Riverside County Standard 309.  _____ (words)	\$ _____	\$ _____
35	21,391	SF	Install 5.5" thick PCC pavement.  _____ (words)	\$ _____	\$ _____
36	637	SF	Construct commercial driveway per Riverside County Standard 207A.  _____ (words)	\$ _____	\$ _____

**VALLEY-WIDE RECREATION**

**REGIONAL PARK ACCESSIBILITY IMPROVEMENT PROJECT**

**BIDDING SHEETS**

<b>Bid Item</b>	<b>Aprox. Qty.</b>	<b>Unit</b>	<b>Description Unit Price Written in Words</b>	<b>Unit Price (Figures)</b>	<b>Total Amount (Figures)</b>
37	1	EA	Remove existing tree, per plan.  _____ (words)	\$ _____	\$ _____
38	1	EA	Relocate existing utility box.  _____ (words)	\$ _____	\$ _____
39	1	EA	Relocate existing parking lot sign behind proposed sidewalk.  _____ (words)	\$ _____	\$ _____
40	61	SF	Construct 8.0' wide concrete ribbon gutter.  _____ (words)	\$ _____	\$ _____
41	49	LF	Curb face transition, 6" to 0".  _____ (words)	\$ _____	\$ _____
42	102,566	SF	Pulverize and Pave 3" AC of remaining portions of parking lots that were not R/R as part of project plans. Work of north and south parking lots to be performed separately (two move-ins) to provide usability of at least one at all times.  _____ (words)	\$ _____	\$ _____
43	780	SF	Remove and replace 26 concrete panels, per "Additional R/R Concrete Exhibit".  _____ (words)	\$ _____	\$ _____
<b>MISCELLANEOUS ITEMS</b>					
44	1	LS	Mobilization and Approved: Bonds, Insurance, Schedule of Values (see Section 01026) and Preliminary Project Schedule (not to exceed 10%)  _____ (words)	\$ _____	\$ _____

**VALLEY-WIDE RECREATION**

**REGIONAL PARK ACCESSIBILITY IMPROVEMENT PROJECT**

**BIDDING SHEETS**

<b>Bid Item</b>	<b>Aprox. Qty.</b>	<b>Unit</b>	<b>Description Unit Price Written in Words</b>	<b>Unit Price (Figures)</b>	<b>Total Amount (Figures)</b>
45	1	LS	Temporary Fencing  _____ (words)	\$ _____	\$ _____
<b>TOTAL BID AMOUNT (Bid Items 1 – 45)</b>					
_____ (words)				\$ _____	



## **EQUIPMENT AND MATERIAL**

No substitution will be permitted without written justification and the approval of the District prior to the bid opening.

**PRODUCTS OF MANUFACTURERS LISTED AS EQUALS TO THOSE SPECIFIED IN THE CONTRACT DOCUMENTS MUST BE SUBMITTED FOR REVIEW AND APPROVAL BY THE DISTRICT NO LATER THAN THE TENTH (10TH) DAY PRECEDING THE DATE SET FOR RECEIPT OF BIDS.**

**VALLEY-WIDE RECREATION**

**REGIONAL PARK ACCESSIBILITY IMPROVEMENT PROJECT**

**BIDDER'S 3-YEAR EXPERIENCE  
RECORD & RESUMES OF KEY PERSONNEL**

All bidders must provide a **detailed three (3) year** experience record showing successful completion, as a licensed **Class A General Contractor or Class B General Builder** contractor, of at least three (3) similar projects within the last **three (3)** years as follows:

- 1. Public Works**
- 2. \$400,000 or greater contract value**
- 3. Owner occupied renovation projects**
- 4. Renovation of publicly accessible areas while maintaining public access for public administration buildings, hospitals, or schools.**

Additionally, bidders must include resumes of key personnel proposed to work on this project when submitting your bid. This information will be critical in determining the most responsible bidder.

Provide client reference contact information for each of the Projects submitted.

**Failure to submit any of the above-mentioned information with your bid  
“may” deem your bid non-responsive**

**VALLEY-WIDE RECREATION**  
**REGIONAL PARK ACCESSIBILITY IMPROVEMENT PROJECT**  
**BIDDER'S 3-YEAR EXPERIENCE**  
**RECORD & RESUMES OF KEY PERSONNEL**

**Bidder Information and Experience Form**

**ARTICLE 1. INFORMATION ABOUT BIDDER**

(Indicate not applicable ("N/A") where appropriate.)

**NOTE:** Where Bidder is a joint venture, pages shall be duplicated and information provided for all parties to the joint venture.

1.0 Name of Bidder: \_\_\_\_\_

2.0 Type, if Entity: \_\_\_\_\_

3.0 Bidder Address: \_\_\_\_\_

\_\_\_\_\_  
\_\_\_\_\_

Facsimile Number

Telephone Number

\_\_\_\_\_  
Email Address

4.0 How many years has Bidder's organization been in business as a Contractor?  
\_\_\_\_\_

5.0 How many years has Bidder's organization been in business under its present name? \_\_\_\_\_

5.1 Under what other or former names has Bidder's organization operated? \_\_\_\_\_

6.0 If Bidder's organization is a corporation, answer the following:

6.1 Date of Incorporation: \_\_\_\_\_

6.2 State of Incorporation: \_\_\_\_\_

6.3 President's Name: \_\_\_\_\_

6.4 Vice-President's Name(s): \_\_\_\_\_

\_\_\_\_\_

6.5 Secretary's Name: \_\_\_\_\_

**VALLEY-WIDE RECREATION**

**REGIONAL PARK ACCESSIBILITY IMPROVEMENT PROJECT**

**BIDDER'S 3-YEAR EXPERIENCE  
RECORD & RESUMES OF KEY PERSONNEL**

6.6 Treasurer's Name: \_\_\_\_\_

7.0 If an individual or a partnership, answer the following:

7.1 Date of Organization: \_\_\_\_\_

7.2 Name and address of all partners (state whether general or limited partnership):

\_\_\_\_\_  
\_\_\_\_\_  
\_\_\_\_\_

8.0 If other than a corporation or partnership, describe organization and name principals:

\_\_\_\_\_  
\_\_\_\_\_

9.0 List other states in which Bidder's organization is legally qualified to do business.

\_\_\_\_\_  
\_\_\_\_\_  
\_\_\_\_\_

10.0 What type of work does the Bidder normally perform with its own forces?

\_\_\_\_\_  
\_\_\_\_\_

11.0 Has Bidder ever failed to complete any work awarded to it? If so, note when, where, and why:

\_\_\_\_\_  
\_\_\_\_\_

12.0 Within the last five years, has any officer or partner of Bidder's organization ever been an officer or partner of another organization when it failed to complete a contract? If so, attach a separate sheet of explanation:

\_\_\_\_\_

**VALLEY-WIDE RECREATION**

**REGIONAL PARK ACCESSIBILITY IMPROVEMENT PROJECT**

**BIDDER'S 3-YEAR EXPERIENCE  
RECORD & RESUMES OF KEY PERSONNEL**

---

13.0 List Trade References:

---

---

---

---

14.0 List Bank References (Bank and Branch Address):

---

---

---

---

15.0 Name of Bonding Company and Name and Address of Agent:

---

---

---

**[REMAINDER OF THIS PAGE INTENTIONALLY LEFT BLANK]**





**VALLEY-WIDE RECREATION**

**REGIONAL PARK ACCESSIBILITY IMPROVEMENT PROJECT**

**BIDDER'S 3-YEAR EXPERIENCE  
RECORD & RESUMES OF KEY PERSONNEL**

**ARTICLE 4. EXPERIENCE AND TECHNICAL QUALIFICATIONS QUESTIONNAIRE**

***Personnel:***

The Bidder shall identify the key personnel to be assigned to this project in a management, construction supervision or engineering capacity.

1. List each person's job title, name and percent of time to be allocated to this project:

---

---

---

2. Summarize each person's specialized education:

---

---

---

3. List each person's years of construction experience relevant to the project:

---

---

---

4. Summarize such experience:

---

---

---

Bidder agrees that personnel named in this Bid will remain on this Project until completion of all relevant Work, unless substituted by personnel of equivalent experience and qualifications approved in advance by the District.

***Changes Occuring Since Prequalification***

If any substantive changes have occurred since Bidder submitted its prequalification package for this Project, Bidder shall list them below. If none are listed, Bidder certifies that no substantive changes have occurred.

---

---



**VALLEY-WIDE RECREATION**

**REGIONAL PARK ACCESSIBILITY IMPROVEMENT PROJECT**

**BIDDER'S 3-YEAR EXPERIENCE  
RECORD & RESUMES OF KEY PERSONNEL**

***Additional Bidder's Statements:***

If the Bidder feels that there is additional information which has not been included in the questionnaire above, and which would contribute to the qualification review, it may add that information in a statement here or on an attached sheet, appropriately marked:

---

---

---

---

---

---

**ARTICLE 5. VERIFICATION AND EXECUTION**

These Bid Forms shall be executed only by a duly authorized official of the Bidder:

I declare under penalty of perjury under the laws of the State of California that the foregoing information is true and correct:

Name of Bidder \_\_\_\_\_

Signature \_\_\_\_\_

Name \_\_\_\_\_

Title \_\_\_\_\_

Date \_\_\_\_\_

## DESIGNATION OF SUBCONTRACTORS

In compliance with the provisions of Sec. 4100-4111, inclusive, of the Public Contract Code of the State of California, and any amendments thereof, each bidder shall set forth below: (a) The name and the location of the place of business of each subcontractor who will perform work or labor or render service to the Contractor in or about the construction of the work or improvement in an amount in excess of one-half of one percent (1/2 of 1%) of the Contractor's total bid; and (b) the portion of the work which will be done by each such subcontractor.

**Each subcontractor shall possess, both at the time the bid is submitted and at all times when work is performed, a valid contractor's license for the appropriate classification necessary to perform the work for which that subcontractor is listed. Each subcontractor shall be registered with the Department of Industrial Relations at time of bid and during the performance of the Contract.**

If the Contractor fails to specify a subcontractor for any portion of the work to be performed under the contract in excess of one-half of one percent (1/2 of 1%) of the Contractor's total bid, he agrees that he is fully qualified to perform that work himself, and that he shall perform that work himself, and that he shall perform that portion himself.

The Contractor shall not, without the consent of the District, or unless, either: (a) Substitute any person as subcontractor in place of the subcontractor designated in the original bid; (b) Permit any such subcontract to be assigned or transferred or allow it to be performed by anyone other than the original subcontractor listed in the bid; or (c) Sublet or subcontract any portion of the work in excess of one-half of one percent (1/2 of 1%) of the Contractor's total bid as to which his original bid did not designate a subcontractor.

In the following instances, the District may consent to the substitution of another subcontractor:

(1) When the subcontractor listed in the bid after having a reasonable opportunity to do so fails or refuses to execute the written contract which is based upon the general terms, conditions, plans and specifications of the involved project or the terms of the subcontractor's written bid when it is presented to the subcontractor by the prime subcontractor;

(2) When the listed subcontractor becomes bankrupt or insolvent;

(3) When the listed subcontractor fails or refuses to perform his or her subcontract;

(4) When the listed subcontractor fails or refuses to meet the bond requirements of the prime Contractor to furnish a bond guaranteeing prompt and faithful performance of the subcontract and the payment of all claims for labor and materials furnished or used pursuant to Public Contract Code 4108;

(5) When the prime Contractor demonstrates to the District, as set forth in Public Contract Code 4107.5 that the name of the subcontractor was listed as the result of an inadvertent clerical error;

As a condition to assert claim of clerical error, the Contractor must give written notice of the inadvertent clerical error to the District with copies to both the listed and intended subcontractor within two (2) working days of the time of the prime bid opening. The District shall consent to the substitution if the prime Contractor and both subcontractor listed in error and the intended subcontractor each submit an affidavit to the District within eight (8) working days of the time of the prime bid opening indicating that an inadvertent clerical error was made.

The District shall also consent to the substitution of the intended Contractor if affidavits are filed by both the prime Contractor and the intended Subcontractor within six (6) working days and the subcontractor claimed to be listed in error does not submit within six (6) working days a written objection to the claim to both the District and the Contractor.

However, if the listed subcontractor submits a written objection to the Contractor's claim of inadvertent clerical error within six (6) working days from the time of the prime bid opening, the District shall investigate the claims of the parties and shall hold a public hearing as described herein to determine the validity of those claims.

Any declarations submitted must be submitted under penalty of perjury by all three (3) parties and supported by testimony under oath and subject to cross-examination.

(6) When the listed Contractor is not licensed pursuant to the Contractor's license law;

(7) When the District determines that the work performed by the listed subcontractor is substantially unsatisfactory and not in substantial accordance with the plans and specifications, or that the subcontractor is substantially delaying or disrupting the progress of the work.

Prior to any substitution of a subcontractor, the District shall give notice in writing to the listed subcontractor of the request to substitute subcontractors and the reasons for the request. The notice shall be served by registered or certified mail to the last known address of the subcontractor. The listed subcontractor who has been so notified shall have five (5) working days within which to submit written objections to the substitution to the District. Failure to file these written objections shall constitute the listed subcontractor's consent to the substitution. If written objections are filed, the District shall give notice in writing of at least five (5) working days to the listed subcontractor of a hearing by the District on the Contractor's request for substitution.

The original bid need not designate a subcontractor for the performance of any change orders.

No subletting or subcontracting of any portion of the work in excess of one-half of one percent (1/2 of 1%) of the prime Contractor's total bid shall be permitted except in cases of public emergency or necessity and then only after a written finding is made by the District as a public record setting forth the facts constituting the emergency or necessity.

As used in this designation, the term subcontractor means only those subcontractors who contract directly with the prime Contractor.

If the Contractor violates any of the provisions of this section, it is deemed to have violated and breached this contract, and the District may exercise the option in its own discretion of: (1) canceling the contract; or (2) assessing the contract or a penalty in an amount of not more than ten percent (10%) of the amount of the subcontract involved, and this penalty shall be deposited in the fund out of which the prime contract is awarded. The Contractor shall be entitled to a public hearing in five (5) days notice of the time and place of the hearing.

**LIST OF DESIGNATED SUBCONTRACTORS**

<b>SPEC #:</b>	2020-120
<b>PROJECT TITLE:</b>	Regional Park Accessibility Improvement Project
<b>NAME OF CONTRACTOR:</b>	

In compliance with the provisions of Sec. 4100-4111, inclusive, of the Public Contract Code of the State of California, and any amendments thereof, each bidder shall set forth: the name, location of the place of business, license number, portion of the work which will be done by each subcontractor who will perform work or labor or render service to the Contractor in or about the construction of the work or improvement in an amount in excess of one-half of one percent (1/2 of 1%) of the Contractor's total bid. Each portion of Subcontracted work noted in the below table must be specific and contain all major activities associated with completion of the project, outside of the services provided by the bidding Contractor. Ambiguous and/or incomplete Subcontracted work information may deem the bid nonresponsive. **Each subcontractor shall possess, both at the time the bid is submitted and at all times when work is performed, a valid contractor's license for the appropriate classification necessary to perform the work for which that subcontractor is listed.**

**BIDDER SHALL PROVIDE THE FOLLOWING INFORMATION:**

**Company Name, Business Address, Email Address, License No., Contractor Registration No., Subcontract Work, and % Of Total Bid**

**\* PLEASE WRITE LEGIBLY\***

LICENSED SUBCONTRACTOR'S NAME, BUSINESS ADDRESS, & EMAIL ADDRESS	LICENSE #	SUBCONTRACT WORK <b>(Be Specific)</b>	% OF TOTAL BID
	CONTRACTOR REGISTRATION #		
<i>Company Name:</i>	<i>License #:</i>		
<i>Address:</i>	<i>DIR Registration #:</i>		
<i>Email Address:</i>			
<i>Company Name:</i>	<i>License #:</i>		
<i>Address:</i>	<i>DIR Registration #:</i>		
<i>Email Address:</i>			

LICENSED SUBCONTRACTOR'S NAME, BUSINESS ADDRESS, & EMAIL ADDRESS	LICENSE #	SUBCONTRACT WORK <i>(Be Specific)</i>	% OF TOTAL BID
<i>Company Name:</i> <hr/> <i>Address:</i> <hr/> <i>Email Address:</i>	<i>License #:</i> <hr/> <i>DIR Registration #:</i>		
<i>Company Name:</i> <hr/> <i>Address:</i> <hr/> <i>Email Address:</i>	<i>License #:</i> <hr/> <i>DIR Registration #:</i>		
<i>Company Name:</i> <hr/> <i>Address:</i> <hr/> <i>Email Address:</i>	<i>License #:</i> <hr/> <i>DIR Registration #:</i>		
<i>Company Name:</i> <hr/> <i>Address:</i> <hr/> <i>Email Address:</i>	<i>License #:</i> <hr/> <i>DIR Registration #:</i>		
<i>Company Name:</i> <hr/> <i>Address:</i> <hr/> <i>Email Address:</i>	<i>License #:</i> <hr/> <i>DIR Registration #:</i>		

(Do not list alternative subcontractors for the same work) (Use additional pages if needed)

**Public Works Contractor Registration Certification**

Pursuant to Labor Code sections 1725.5 and 1771.1

All contractors and subcontractors that wish to bid on, be listed in a bid proposal, or enter into a contract to perform public work must be registered with the Department of Industrial Relations. See <http://www.dir.ca.gov/Public-Works/PublicWorks.html> for additional information.

No bid will be accepted nor any contract entered into without proof of the contractor's and subcontractors' current registration with the Department of Industrial Relations to perform public work.

Bidder hereby certifies that it is aware of the registration requirements set forth in Labor Code sections 1725.5 and 1771.1 and is currently registered as a contractor with the Department of Industrial Relations.

Name of Bidder: \_\_\_\_\_

DIR Registration Number: \_\_\_\_\_

DIR Registration Expiration: \_\_\_\_\_

Bidder further acknowledges:

1. Bidder shall maintain a current DIR registration for the duration of the project.
2. Bidder shall include the requirements of Labor Code sections 1725.5 and 1771.1 in its contract with subcontractors and ensure that all subcontractors are registered at the time of bid opening and maintain registration status for the duration of the project.
3. Failure to submit this form or comply with any of the above requirements may result in a finding that the bid is non-responsive.

Name of Bidder \_\_\_\_\_

Signature \_\_\_\_\_

Name and Title \_\_\_\_\_

Dated \_\_\_\_\_

**CONTRACTOR'S LICENSING STATEMENT**

The undersigned is licensed in accordance with the laws of the State of \_\_\_\_\_ providing for the registration of contractors. The representations made herein and in the proposal documents are made under penalty of perjury. The undersigned is hereby representing that he is properly licensed both at the time that he submits a bid as well as at the time the contract is awarded, if the contract is awarded to the undersigned.

**CONTRACTOR'S CLASSIFICATION** \_\_\_\_\_

**LICENSE NUMBER** \_\_\_\_\_ **TYPE** \_\_\_\_\_ **EXPIRATION DATE** \_\_\_\_\_

**A. INDIVIDUAL CONTRACTOR**

<b>NAME OF INDIVIDUAL CONTRACTOR:</b>
<b>BUSINESS ADDRESS:</b>
<b>PHONE NUMBER:</b>
<b>SIGNATURE OF OWNER:</b>

**B. FIRM OR PARTNERSHIP**

<b>NAME OF FIRM OR PARTNERSHIP:</b>
<b>BUSINESS ADDRESS:</b>
<b>PHONE NUMBER:</b>
<b>SIGNATURE(S) &amp; TITLE OF MEMBERS SIGNING ON BEHALF OF THE PARTNERSHIP:</b>
<b>SIGNATURE:</b> _____ <b>TITLE:</b> _____
<b>SIGNATURE:</b> _____ <b>TITLE:</b> _____
<b>SIGNATURE:</b> _____ <b>TITLE:</b> _____

**C. CORPORATION**

<b>NAME OF CORPORATION:</b>
<b>BUSINESS ADDRESS:</b>
<b>PHONE NUMBER:</b>
<b>SIGNATURE OF AUTHORIZED OFFICER OF CORPORATION:</b>
<b>SIGNATURE:</b> _____ <b>TITLE:</b> _____



**NON-COLLUSION DECLARATION**

**TO BE EXECUTED BY BIDDER AND SUBMITTED WITH BID**

The undersigned declares:

I am the \_\_\_\_\_ of \_\_\_\_\_,  
the party making the foregoing bid.

The bid is not made in the interest of, or on behalf of, any undisclosed person, partnership, company, association, organization, or corporation. The bid is genuine and not collusive or sham. The bidder has not directly or indirectly induced or solicited any other bidder to put in a false or sham bid. The bidder has not directly or indirectly colluded, conspired, connived, or agreed with any bidder or anyone else to put in a sham bid, or to refrain from bidding. The bidder has not in any manner, directly or indirectly, sought by agreement, communication, or conference with anyone to fix the bid price of the bidder or of any other bidder, or to fix any overhead, profit, or cost element of the bid price, or of that of any other bidder. All statements contained in the bid are true. The bidder has not, directly or indirectly, submitted his or her bid price or any breakdown thereof, or the contents thereof, or divulged information or data relative thereto, to any corporation, partnership, company, association, organization, bid depository, or to any member or agent thereof, to effectuate a collusive or sham bid, and has not paid, and will not pay, any person or entity for such purpose.

Any person executing this declaration on behalf of a bidder that is a corporation, partnership, joint venture, limited liability company, limited liability partnership, or any other entity, hereby represents that he or she has full power to execute, and does execute, this declaration on behalf of the bidder.

I declare under penalty of perjury under the laws of the State of California that the foregoing is true and correct and that this declaration is executed on \_\_\_\_\_ [date],  
at \_\_\_\_\_ [city], \_\_\_\_\_ [state]

Signed: \_\_\_\_\_

Name: \_\_\_\_\_  
*(Print Name Here)*

Project Title: Regional Park Accessibility Improvement Project

**WORKERS' COMPENSATION INSURANCE CERTIFICATE**

The Contractor shall execute the following form as required by the California Labor Code, Sections 1860 and 1861:

I am aware of the provisions of Section 3700 of the Labor Code which require every employer to be insured against liability for workers' compensation or to undertake self-insurance in accordance with the provisions of that code, and I will comply with such provisions before commencing the performance of the work of this contract. Date: (Contractor) By: (Signature) (Title)

Date: \_\_\_\_\_

\_\_\_\_\_  
(Contractor)

By: \_\_\_\_\_  
(Signature)

\_\_\_\_\_  
(Title)

**IRAN CONTRACTING ACT**  
**(Public Contract Code sections 2202-2208)**

Prior to bidding on, submitting a proposal or executing a contract or renewal for a State of California contract for goods or services of \$1,000,000 or more, a vendor must either: a) certify it is **not** on the current list of persons engaged in investment activities in Iran created by the California Department of General Services (“DGS”) pursuant to Public Contract Code section 2203(b) and is not a financial institution extending twenty million dollars (\$20,000,000) or more in credit to another person, for 45 days or more, if that other person will use the credit to provide goods or services in the energy sector in Iran and is identified on the current list of persons engaged in investment activities in Iran created by DGS; or b) demonstrate it has been exempted from the certification requirement for that solicitation or contract pursuant to Public Contract Code section 2203(c) or (d).

To comply with this requirement, please insert your vendor or financial institution name and Federal ID Number (if available) and complete **one** of the options below. Please note: California law establishes penalties for providing false certifications, including civil penalties equal to the greater of \$250,000 or twice the amount of the contract for which the false certification was made; contract termination; and three-year ineligibility to bid on contracts. (Public Contract Code section 2205.)

**OPTION #1 - CERTIFICATION**

I, the official named below, certify I am duly authorized to execute this certification on behalf of the vendor/financial institution identified below, and the vendor/financial institution identified below is **not** on the current list of persons engaged in investment activities in Iran created by DGS and is not a financial institution extending twenty million dollars (\$20,000,000) or more in credit to another person/vendor, for 45 days or more, if that other person/vendor will use the credit to provide goods or services in the energy sector in Iran and is identified on the current list of persons engaged in investment activities in Iran created by DGS.

<i>Vendor Name/Financial Institution (Printed)</i>	<i>Federal ID Number (or n/a)</i>
<i>By (Authorized Signature)</i>	
<i>Printed Name and Title of Person Signing</i>	
<i>Date Executed</i>	<i>Executed in</i>

**OPTION #2 – EXEMPTION**

Pursuant to Public Contract Code sections 2203(c) and (d), a public entity may permit a vendor/financial institution engaged in investment activities in Iran, on a case-by-case basis, to be eligible for, or to bid on, submit a proposal for, or enters into or renews, a contract for goods and services.

If you have obtained an exemption from the certification requirement under the Iran Contracting Act, please fill out the information below, and attach documentation demonstrating the exemption approval.

<i>Vendor Name/Financial Institution (Printed)</i>	<i>Federal ID Number (or n/a)</i>
<i>By (Authorized Signature)</i>	
<i>Printed Name and Title of Person Signing</i>	<i>Date Executed</i>

# **Cal/OSHA Form 300A**

## **Annual Summary of Work-Related Injuries and Illnesses**

**Bidders shall provide the most current, completed  
Cal/OSHA Form 300A with their bid (blank form attached)**

**Failure to submit this form “may” deem your bid non-responsive**

# Annual Summary of Work Related Injuries and Illnesses



All establishments covered by CCR Title 8 Section 14300 must complete this Annual Summary, even if no work-related injuries or illnesses occurred during the year. Remember to review the Log to verify that the entries are complete and accurate before completing this summary.

Using the Log, count the individual entries you made for each category. Then write the totals below, making sure you've added the entries from every page of the Log. If you had no cases, write "0."

Employees, former employees, and their representatives have the right to review the Cal/ OSHA Form 300 in its entirety. They also have limited access to the Cal/ OSHA Form 301 or its equivalent. See CCR Title 8 Section 14300.35, in Cal/ OSHA's recordkeeping rule, for further details on the access provisions for these forms.

### Facility Information

Establishment name \_\_\_\_\_

Street \_\_\_\_\_

City \_\_\_\_\_ State \_\_\_\_\_ Zip \_\_\_\_\_

Industry description (e.g. Manufacturer of motor truck trailers)  
\_\_\_\_\_

Standard Industrial Classification (SIC), if known (e.g. SIC 3715)  
\_\_\_\_\_

### Employment Information

(If you don't have these figures, use the optional Worksheet to estimate)

Annual average number of employees \_\_\_\_\_

Total hours worked by all employees last year \_\_\_\_\_

### Sign here

**Knowingly falsifying this document may result in a fine.**

I certify that I have examined this document and that to the best of my knowledge the entries are true, accurate, and complete.

\_\_\_\_\_  
Company executive Title

\_\_\_\_\_  
Phone Date

### Number of Cases

Total number of deaths	Total number of cases with days away from work	Total number of cases with job transfer or restriction	Total number of other recordable cases
_____	_____	_____	_____
(G)	(H)	(I)	(J)

### Number of Days

Total number of days of job transfer or restriction	Total number of days away from work
_____	_____
(K)	(L)

### Injury and Illness Types

Total number of...	(M)
(1) Injuries	_____
(2) Skin disorders	_____
(3) Respiratory conditions	_____
(4) Poisonings	_____
(5) Hearing loss	_____
(6) All other Illnesses	_____

Post this Annual Summary from February 1 to April 30 of the year following the year covered by the form.

# VALLEY-WIDE RECREATION BID BOND

Bid Bond No.

KNOW ALL MEN BY THESE PRESENTS, that we \_\_\_\_\_  
(Here insert full name and address or legal title of Contractor)

\_\_\_\_\_ as Principal, hereinafter called the Principal, and

\_\_\_\_\_ (Here insert full name and address or legal title of Surety)

A corporation duly organized under the laws of the State of \_\_\_\_\_ as Surety, Hereinafter call the Surety, are held and firmly bound unto Valley-Wide Recreation.

Obligee, hereinafter all the Obligee, in the sum of \_\_\_\_\_

\_\_\_\_\_ Dollars (\_\_\_\_\_),

for the payment of which sum well and truly to be made, the said Principal and the said Surety, bind ourselves, our heir, executors, administrator, successors and assigns, jointly and severally firmly by these presents.

WHEREAS, the Principal has submitted a bid, dated \_\_\_\_\_, 20\_\_\_\_, for \_\_\_\_\_

\_\_\_\_\_ (Here insert full name, address and description of Project)

NOW, THEREFORE, IF THE Obligee shall accept the bid of the Principal and the Principal shall enters into a Contracto with the Obligee in accordance with the terms of such bid, and give such bond or bonds as may be specified in the bidding of Contract Documents with good and sufficient surety for the faithful performance of such Contract and for the prompt payment of labor and material furnished in the prosecution thereof, or in the event of the failure of the Principal to enter such Contract and give such bond or bonds, if the Principal shall pay the Obligee the difference not to exceed the penalty hereof between the amount specified in said bid and such larger amount for which the Obligee may in good faith contract with another party to perform the Work covered by said bid, then this obligation shall be null and void, otherwise to remain in full force and effect.

In the event suit is brought upon this Bond by Obligee and judgement is recovered , the Surety shall pay all costs incurred by Obligee in such suits to be fixed by the court.

Signed and sealed this \_\_\_\_\_ day of \_\_\_\_\_, \_\_\_\_\_

\_\_\_\_\_  
(Witness)

\_\_\_\_\_  
(Principal)

\_\_\_\_\_  
(Title)

\_\_\_\_\_  
(Witness)

\_\_\_\_\_  
(Surety)

\_\_\_\_\_  
(Title)

The Bid Bond (BB-1) form shall be submitted to be considered a responsive bid

**Notary Public Acknowledgement required for Surety  
Per Civil Code 1189 a notice must be legible and provided at the top in an enclosed box to be deemed responsible**

# SAMPLE ALL PURPOSE ACKNOWLEDGEMENT FORM

Per Civil Code 1189 a notice must be legible and provided at the op in an enclosed box to be deemed responsive

**CALIFORNIA ALL-PURPOSE ACKNOWLEDGEMENT**

**CIVIL CODE 1189**

A notary public or other officer completing this certificate verifies only the identity of the individual who signed the document to which this certificate is attached, and not the truthfulness, accuracy, or validity of that document.

State of California

County of

**PERFORMANCE BOND.**

KNOW ALL PERSONS BY THESE PRESENTS:

THAT WHEREAS, the Valley-Wide Recreation and Park District, (hereinafter referred to as "District") has awarded to \_\_\_\_\_, (hereinafter referred to as the "Contractor") an agreement for the **Regional Park Accessibility Improvement Project** (hereinafter referred to as the "Project").

WHEREAS, the work to be performed by the Contractor is more particularly set forth in the Contract Documents for the Project dated \_\_\_\_\_, (hereinafter referred to as "Contract Documents"), the terms and conditions of which are expressly incorporated herein by reference; and

WHEREAS, the Contractor is required by said Contract Documents to perform the terms thereof and to furnish a bond for the faithful performance of said Contract Documents.

NOW, THEREFORE, we, \_\_\_\_\_, the undersigned Contractor and \_\_\_\_\_ as Surety, a corporation organized and duly authorized to transact business under the laws of the State of California, are held and firmly bound unto the District in the sum of \_\_\_\_\_ DOLLARS, (\$\_\_\_\_\_), said sum being not less than one hundred percent (100%) of the total amount of the Contract, for which amount well and truly to be made, we bind ourselves, our heirs, executors and administrators, successors and assigns, jointly and severally, firmly by these presents.

THE CONDITION OF THIS OBLIGATION IS SUCH, that, if the Contractor, his or its heirs, executors, administrators, successors or assigns, shall in all things stand to and abide by, and well and truly keep and perform the covenants, conditions and agreements in the Contract Documents and any alteration thereof made as therein provided, on its part, to be kept and performed at the time and in the manner therein specified, and in all respects according to their intent and meaning; and shall faithfully fulfill all obligations including the one (1) year guarantee of all materials and workmanship; and shall indemnify and save harmless the District, its officials, officers, employees, and authorized volunteers, as stipulated in said Contract Documents, then this obligation shall become null and void; otherwise it shall be and remain in full force and effect.

As a part of the obligation secured hereby and in addition to the face amount specified therefore, there shall be included costs and reasonable expenses and fees including reasonable attorney's fees, incurred by District in enforcing such obligation.

As a condition precedent to the satisfactory completion of the Contract Documents, unless otherwise provided for in the Contract Documents, the above obligation shall hold good for a period of one (1) year after the acceptance of the work by District, during which time if Contractor shall fail to make full, complete, and satisfactory repair and replacements and totally protect the District from loss or damage resulting from or caused by defective materials or faulty workmanship. The obligations of Surety hereunder shall continue so long as any obligation of Contractor remains. Nothing herein shall limit the District's rights or the Contractor or Surety's obligations under the Contract, law or equity, including, but not limited to, California Code of Civil Procedure Section 337.15.



Whenever Contractor shall be, and is declared by the District to be, in default under the Contract Documents, the Surety shall remedy the default pursuant to the Contract Documents, or shall promptly, at the District's option:

- i. Take over and complete the Project in accordance with all terms and conditions in the Contract Documents; or
- ii. Obtain a bid or bids for completing the Project in accordance with all terms and conditions in the Contract Documents and upon determination by Surety of the lowest responsive and responsible bidder, arrange for a Contract between such bidder, the Surety and the District, and make available as work progresses sufficient funds to pay the cost of completion of the Project, less the balance of the contract price, including other costs and damages for which Surety may be liable. The term "balance of the contract price" as used in this paragraph shall mean the total amount payable to Contractor by the District under the Contract and any modification thereto, less any amount previously paid by the District to the Contractor and any other set offs pursuant to the Contract Documents.
- iii. Permit the District to complete the Project in any manner consistent with California law and make available as work progresses sufficient funds to pay the cost of completion of the Project, less the balance of the contract price, including other costs and damages for which Surety may be liable. The term "balance of the contract price" as used in this paragraph shall mean the total amount payable to Contractor by the District under the Contract and any modification thereto, less any amount previously paid by the District to the Contractor and any other set offs pursuant to the Contract Documents.

Surety expressly agrees that the District may reject any contractor or subcontractor which may be proposed by Surety in fulfillment of its obligations in the event of default by the Contractor.

Surety shall not utilize Contractor in completing the Project nor shall Surety accept a bid from Contractor for completion of the Project if the District, when declaring the Contractor in default, notifies Surety of the District's objection to Contractor's further participation in the completion of the Project.

The Surety, for value received, hereby stipulates and agrees that no change, extension of time, alteration or addition to the terms of the Contract Documents or to the Project to be performed thereunder shall in any way affect its obligations on this bond, and it does hereby waive notice of any such change, extension of time, alteration or addition to the terms of the Contract Documents or to the Project.

IN WITNESS WHEREOF, we have hereunto set our hands and seals this \_\_\_\_\_ day of \_\_\_\_\_, 20\_\_\_\_.

(Corporate Seal)

\_\_\_\_\_  
Contractor/ Principal

By \_\_\_\_\_

Title \_\_\_\_\_

(Corporate Seal)

\_\_\_\_\_  
Surety

By \_\_\_\_\_  
Attorney-in-Fact

(Attach Attorney-in-Fact Certificate)

Title \_\_\_\_\_

The rate of premium on this bond is \_\_\_\_\_ per thousand. The total amount of premium charges is \$\_\_\_\_\_.  
(The above must be filled in by corporate attorney.)

THIS IS A REQUIRED FORM

Any claims under this bond may be addressed to:

(Name and Address of Surety) \_\_\_\_\_  
\_\_\_\_\_  
\_\_\_\_\_

(Name and Address of Agent or Representative for service of process in California, if different from above) \_\_\_\_\_  
\_\_\_\_\_  
\_\_\_\_\_

(Telephone number of Surety and Agent or Representative for service of process in California) \_\_\_\_\_



### PAYMENT BOND

KNOW ALL MEN BY THESE PRESENTS That

WHEREAS, the Valley-Wide Recreation and Park District (hereinafter designated as the "District"), by action taken or a resolution passed \_\_\_\_\_, 20\_\_\_\_, has awarded to \_\_\_\_\_ hereinafter designated as the "Principal," a contract for the work described as follows: **Regional Park Accessibility Improvement Project.**

WHEREAS, said Principal is required to furnish a bond in connection with said contract; providing that if said Principal or any of its Subcontractors shall fail to pay for any materials, provisions, provender, equipment, or other supplies used in, upon, for or about the performance of the work contracted to be done, or for any work or labor done thereon of any kind, or for amounts due under the Unemployment Insurance Code or for any amounts required to be deducted, withheld, and paid over to the Employment Development Department from the wages of employees of said Principal and its Subcontractors with respect to such work or labor the Surety on this bond will pay for the same to the extent hereinafter set forth.

NOW THEREFORE, we, the Principal and \_\_\_\_\_ as Surety, are held and firmly bound unto the District in the penal sum of \_\_\_\_\_ Dollars (\$ \_\_\_\_\_) lawful money of the United States of America, for the payment of which sum well and truly to be made, we bind ourselves, our heirs, executors, administrators, successors and assigns, jointly and severally, firmly by these presents.

THE CONDITION OF THIS OBLIGATION IS SUCH that if said Principal, his or its subcontractors, heirs, executors, administrators, successors or assigns, shall fail to pay any of the persons named in Civil Code Section 9100, fail to pay for any materials, provisions or other supplies, used in, upon, for or about the performance of the work contracted to be done, or for any work or labor thereon of any kind, or amounts due under the Unemployment Insurance Code with respect to work or labor performed under the contract, or for any amounts required to be deducted, withheld, and paid over to the Employment Development Department or Franchise Tax Board from the wages of employees of the contractor and his subcontractors pursuant to Revenue and Taxation Code Section 18663, with respect to such work and labor the Surety or Sureties will pay for the same, in an amount not exceeding the sum herein above specified, and also, in case suit is brought upon this bond, all litigation expenses incurred by the District in such suit, including reasonable attorneys' fees, court costs, expert witness fees and investigation expenses.

This bond shall inure to the benefit of any of the persons named in Civil Code Section 9100 so as to give a right of action to such persons or their assigns in any suit brought upon this bond.

It is further stipulated and agreed that the Surety on this bond shall not be exonerated or released from the obligation of this bond by any change, extension of time for performance, addition, alteration or modification in, to, or of any contract, plans, specifications, or agreement pertaining or relating to any scheme or work of improvement herein above described, or pertaining or relating to the furnishing of labor, materials, or equipment therefore, nor by any change or modification of any terms of payment or extension of the time for any payment pertaining or relating to any scheme or work of improvement herein above described, nor by any rescission or attempted rescission or attempted rescission of the contract, agreement or bond, nor by any conditions precedent or subsequent in the bond attempting to limit the right of recovery of claimants otherwise entitled to recover under any such contract or agreement or

under the bond, nor by any fraud practiced by any person other than the claimant seeking to recover on the bond and that this bond be construed most strongly against the Surety and in favor of all persons for whose benefit such bond is given, and under no circumstances shall Surety be released from liability to those for whose benefit such bond has been given, by reason of any breach of contract between the owner or District and original contractor or on the part of any obligee named in such bond, but the sole conditions of recovery shall be that claimant is a person described in Civil Code Section 9100, and has not been paid the full amount of his claim and that Surety does hereby waive notice of any such change, extension of time, addition, alteration or modification herein mentioned, including but not limited to the provisions of sections 2819 and 2845 of the California Civil Code.

IN WITNESS WHEREOF, we have hereunto set our hands and seals this \_\_\_\_\_ day of \_\_\_\_\_, 20\_\_.

(Corporate Seal)

\_\_\_\_\_  
Contractor/ Principal

By \_\_\_\_\_

Title \_\_\_\_\_

(Corporate Seal)

\_\_\_\_\_  
Surety

By \_\_\_\_\_  
Attorney-in-Fact

(Attach Attorney-in-Fact Certificate)

Title \_\_\_\_\_





## CONTRACT

This CONTRACT, is made and entered into this \_\_\_\_ day of \_\_\_\_\_, 2018, by and between Valley-Wide Recreation and Park District, sometimes hereinafter called "District," and "Contractor Name", sometimes hereinafter called "Contractor."

WITNESSETH: That the parties hereto have mutually covenanted and agreed, and by these presents do covenant and agree with each other as follows:

a. **SCOPE OF WORK.** The Contractor shall perform all Work within the time stipulated in the Contract, and shall provide all labor, materials, equipment, tools, utility services, and transportation to complete all of the Work required in strict compliance with the Contract Documents as specified in Article 5, below, for the following Project:

### Regional Park Accessibility Improvement Project

The Contractor and its surety shall be liable to the District for any damages arising as a result of the Contractor's failure to comply with this obligation.

b. **TIME FOR COMPLETION.** Time is of the essence in the performance of the Work. The Work shall be commenced on the date stated in the District's Notice of Acceptance of Proposal / Notice to Proceed. The Contractor shall complete all Work required by the Contract Documents within one hundred eighty (180) calendar days from the commencement date stated in the Notice to Proceed. By its signature hereunder, Contractor agrees the time for completion set forth above is adequate and reasonable to complete the Work.

c. **CONTRACT PRICE.** The District shall pay to the Contractor as full compensation for the performance of the Contract, subject to any additions or deductions as provided in the Contract Documents, and including all applicable taxes and costs, the sum of "DOLLAR AMOUNT IN WORDS" (\$#####.##). Payment shall be made as set forth in the General Conditions.

d. **LIQUIDATED DAMAGES.** In accordance with Government Code section 53069.85, it is agreed that the Contractor will pay the District \$250.00 for each and every calendar day of delay beyond the time prescribed in the Contract Documents for finishing the Work, as Liquidated Damages and not as a penalty or forfeiture. In the event this is not paid, the Contractor agrees the District may deduct that amount from any money due or that may become due the Contractor under the Contract. This Article does not exclude recovery of other damages specified in the Contract Documents.

e. **COMPONENT PARTS OF THE CONTRACT.** The "Contract Documents" include the following:

- Notice Inviting Bids
- Instructions to Bidders
- Bid Form
- Bid Bond
- Designation of Subcontractors
- Information Required of Bidders
- Non-Collusion Declaration Form



Iran Contracting Act Certification  
Public Works Contractor Registration Certification  
Performance Bond  
Payment (Labor and Materials) Bond  
General Conditions  
Special Conditions  
Technical Specifications  
Addenda  
Plans and Drawings  
Standard Specifications for Public Works Construction "Greenbook", latest edition,  
Except Sections 1-9  
Applicable Local Agency Standards and Specifications, as last revised  
Approved and fully executed change orders  
Any other documents contained in or incorporated into the Contract

The Contractor shall complete the Work in strict accordance with all of the Contract Documents.

All of the Contract Documents are intended to be complementary. Work required by one of the Contract Documents and not by others shall be done as if required by all. This Contract shall supersede any prior agreement of the parties.

f. **PROVISIONS REQUIRED BY LAW AND CONTRACTOR COMPLIANCE.** Each and every provision of law required to be included in these Contract Documents shall be deemed to be included in these Contract Documents. The Contractor shall comply with all requirements of applicable federal, state and local laws, rules and regulations, including, but not limited to, the provisions of the California Labor Code and California Public Contract Code which are applicable to this Work.

g. **INDEMNIFICATION.** Contractor shall provide indemnification and defense as set forth in the General Conditions.

h. **PREVAILING WAGES.** Contractor shall be required to pay the prevailing rate of wages in accordance with the Labor Code which such rates shall be made available at the District's Administrative Office or may be obtained online at <http://www.dir.ca.gov> and which must be posted at the job site.

**[REMAINDER OF PAGE LEFT INTENTIONALLY BLANK]**

IN WITNESS WHEREOF, this Contract has been duly executed by the above-named parties, on the day and year above written.

**CONTRACTOR NAME**

\_\_\_\_\_  
Name of Contractor

**VALLEY-WIDE RECREATION AND  
PARK DISTRICT**

By \_\_\_\_\_

Name and Title: \_\_\_\_\_

License No. \_\_\_\_\_

Date: \_\_\_\_\_

By \_\_\_\_\_  
Dean Wetter, General Manager

Date: \_\_\_\_\_

**(CONTRACTOR'S SIGNATURE MUST BE  
NOTARIZED AND CORPORATE  
SEAL AFFIXED, IF APPLICABLE)**

Approved as to form this \_\_\_\_\_ day of \_\_\_\_\_ 20\_\_\_\_.

\_\_\_\_\_  
Attorney for Valley-Wide Recreation and  
Park District

**END OF CONTRACT**

# Notary Acknowledgment

A notary public or other officer completing this certificate verifies only the identity of the individual who signed the document to which this certificate is attached, and not the truthfulness, accuracy, or validity of that document.

STATE OF CALIFORNIA  
COUNTY OF \_\_\_\_\_

On \_\_\_\_\_, 20\_\_\_\_, before me, \_\_\_\_\_, Notary Public, personally appeared \_\_\_\_\_, who proved to me on the basis of satisfactory

evidence to be the person(s) whose name(s) is/are subscribed to the within instrument and acknowledged to me that he/she/they executed the same in his/her/their authorized capacity(ies), and that by his/her/their signature(s) on the instrument the person(s), or the entity upon behalf of which the person(s) acted, executed the instrument.

I certify under PENALTY OF PERJURY under the laws of the State of California that the foregoing paragraph is true and correct.

WITNESS my hand and official seal.

Signature of Notary Public

## OPTIONAL

*Though the information below is not required by law, it may prove valuable to persons relying on the document and could prevent fraudulent removal and reattachment of this form to another document.*

### CAPACITY CLAIMED BY SIGNER

### DESCRIPTION OF ATTACHED DOCUMENT

- Individual
- Corporate Officer

\_\_\_\_\_ Title(s)

\_\_\_\_\_ Title or Type of Document

- Partner(s)  Limited
- General

\_\_\_\_\_ Number of Pages

- Attorney-In-Fact
- Trustee(s)
- Guardian/Conservator
- Other:

\_\_\_\_\_ Date of Document

Signer is representing:  
Name Of Person(s) Or Entity(ies)

\_\_\_\_\_  
\_\_\_\_\_

\_\_\_\_\_ Signer(s) Other Than Named Above

MEMORANDUM



**VALLEY-WIDE**  
RECREATION AND PARK DISTRICT

**GoRecreation.org**  
*AWARD WINNING CALIFORNIA PARKS*

---

---

TO: Whom It May Concern

FROM: Valley-Wide Recreation and Park District

SUBJECT: Insurance Requirements

---

---

**Insurance:** Each group needs to provide Valley-Wide Recreation and Park District with a Certificate of Insurance naming **Valley-Wide Recreation and Park District** as Additional Insured, (\$1,000,000 General Liability Limit with a \$2,000,000 General Aggregate Limit). Also, must include **Form Number CG2010, Additional Endorsement** with Valley-Wide Recreation and Park District listed as Additional Insured. (Or applicable approved form from the Insurance Carrier.) **A minimum of 10 Days' Notice of Cancellation is required.**

**ALSO:** Please have the statement: "**Throughout Various Valley-Wide Recreation Facilities**" added to the Description of Operations Box on the certificate of Insurance. (This is to cover the use of all facility sites within our District that may be requested)

Note: Anyone utilizing the facility and having alcohol present, must also include Liquor Liability Coverage on the Certificate of Insurance.

**Certificate Holder and Additional Endorsement should name:**

Valley-Wide Recreation & Park District  
901 W. Esplanade Ave.  
San Jacinto, Ca 92582

**Please Note:** When submitting the Certificate and Additional Endorsement forms to Valley-Wide Recreation, please include the following information on a front cover page or envelope. This will ensure that the forms will be directed to the correct Valley-Wide Recreation site and Supervisor.

**Facility SITE: District Office                      ATTN: James Salvador**

Facility Contact Number (for any questions): (951) 654-1505

Facility FAX: (951) 654-5279    Contact EMAIL: JamesS@GoRecreation.org

**GENERAL CONDITIONS**  
**Section F – Labor & Construction**  
**Table of Contents**

ARTICLE 1 - DEFINITIONS.....	F1
ARTICLE 2 - CONTRACT DOCUMENTS.....	F5
ARTICLE 3 - PRECONSTRUCTION AND CONSTRUCTION COMMUNICATION.....	F6
ARTICLE 4 - CONTRACT DOCUMENTS: COPIES & MAINTENANCE .....	F6
ARTICLE 5 - EXAMINATION OF DRAWINGS, SPECIFICATION & SITE WORK.....	F6
ARTICLE 6 - MOBILIZATION .....	F7
ARTICLE 7 - EXISTENCE OF UTILITIES AT THE WORK SITE .....	F8
ARTICLE 8 - SOILS INVESTIGATIONS .....	F9
ARTICLE 9 - CONTRACT SUPERVISION.....	F9
ARTICLE 10 - WORKERS.....	F9
ARTICLE 11 - INDEPENDENT CONTRACTORS.....	F10
ARTICLE 12 - SUBCONTRACTS .....	F10
ARTICLE 13 - VERIFICATIONS OF EMPLOYMENT ELIGIBILITY.....	F10
ARTICLE 14 - REQUEST FOR SUBSTITUTION .....	F10
ARTICLE 15 - SHOP DRAWINGS.....	F12
ARTICLE 16 - SUBMITTALS.....	F12
ARTICLE 17 - MATERIALS.....	F13
ARTICLE 18 - PERMITS AND LICENSES.....	F13
ARTICLE 19 - TRENCHES .....	F14
ARTICLE 20 - TRAFFIC CONTROL .....	F15
ARTICLE 21 - DIVERSION OF RECYCLEABLE WASTE MATERIALS .....	F16
ARTICLE 22 - REMOVAL OF HAZARDOUS MATERIALS .....	F16
ARTICLE 23 - SANITARY FACILITIES .....	F16
ARTICLE 24 - AIR POLLUTION CONTROL.....	F16
ARTICLE 25 - LAYOUT AND FIELD ENGINEERING.....	F16
ARTICLE 26 - TESTS AND INSPECTIONS.....	F17
ARTICLE 27 - PROTECTION OF WORK AND PROPERTY.....	F17
ARTICLE 28 - CONTRACTORS MEANS AND METHODS .....	F18
ARTICLE 29 - AUTHORIZED REPRESENTATIVES .....	F18
ARTICLE 30 - HOURS OF WORK.....	F18
ARTICLE 31 - PAYROLL RECORDS .....	F19
ARTICLE 32 - PREVAILING RATES OF WAGES .....	F20
ARTICLE 33 - PUBLIC WORKS CONTRACTOR REGISTRATION.....	F21
ARTICLE 34 - EMPLOYMENT OF APPRENTICES .....	F21
ARTICLE 35 - NONDISCRIMINATION EQUAL EMPLOYMENT OPPORTUNITY .....	F22
ARTICLE 36 - DEBARMENT OF CONTRACTORS AND SUBCONTRACTORS.....	F22
ARTICLE 37 - LABOR EMPLOYMENT SAFETY .....	F23
ARTICLE 38 - INSURANCE.....	F23
ARTICLE 39 - FORM AND PROOF OF CARRIAGE OF INSURANCE .....	F27
ARTICLE 40 - TIME FOR COMPLETION AND LIQUIDATED DAMAGES .....	F28
ARTICLE 41 - COST BREAKDOWN AND INVOICING .....	F29

**GENERAL CONDITIONS**  
**Section F – Labor & Construction**  
**Table of Contents**

<b>ARTICLE 42 - PROGRESS ESTIMATES AND PAYMENTS .....</b>	<b>F29</b>
<b>ARTICLE 43 - SECURITIES FOR MONEY WITHHELD.....</b>	<b>F31</b>
<b>ARTICLE 44 - CHANGES AND EXTRA WORK .....</b>	<b>F31</b>
<b>ARTICLE 45 - FINAL ACCEPTANCE AND PAYMENT .....</b>	<b>F43</b>
<b>ARTICLE 46 - OCCUPANCY.....</b>	<b>F44</b>
<b>ARTICLE 47 - INDEMINIFICATION.....</b>	<b>F45</b>
<b>ARTICLE 48 - PROCEDURE FOR RESOLVING DISPUTES.....</b>	<b>F46</b>
<b>ARTICLE 49 - DISTRICT’S RIGHT TO TERMINATE CONTRACT .....</b>	<b>F47</b>
<b>ARTICLE 50 - WARRANTY AND GUARANTEE OF WORK .....</b>	<b>F50</b>
<b>ARTICLE 51 - DOCUMENT RETENTION &amp; EXAMINATION.....</b>	<b>F53</b>
<b>ARTICLE 52 - SEPARATE CONTRACTS .....</b>	<b>F53</b>
<b>ARTICLE 53 - NOTICE AND SERVICE THEREOF.....</b>	<b>F54</b>
<b>ARTICLE 54 - NOTICE OF THIRD PARTY CLAIMS .....</b>	<b>F54</b>
<b>ARTICLE 55 - STATE LICENSE BOARD NOTICE.....</b>	<b>F54</b>
<b>ARTICLE 56 - INTEGRATION .....</b>	<b>F54</b>
<b>ARTICLE 67 - ASSIGNMENT OF CONTRACT.....</b>	<b>F54</b>
<b>ARTICLE 58 - CHANGE IN NAME AND NATURE OF CONTACTOR’S LEGAL ENTITY.....</b>	<b>F55</b>
<b>ARTICLE 59 - ASSISNGMENT OF ANTITRUST ACTIONS .....</b>	<b>F55</b>
<b>ARTICLE 60 - PROHIBITED INTERESTS .....</b>	<b>F55</b>
<b>ARTICLE 61 - CONTROLLING LAW.....</b>	<b>F55</b>
<b>ARTICLE 62 - JURISDICTION; VENUE .....</b>	<b>F55</b>
<b>ARTICLE 63 - LAWS AND REGULATIONS .....</b>	<b>F55</b>
<b>ARTICLE 64 - PATENTS .....</b>	<b>F56</b>
<b>ARTICLE 65 - OWNERSHIP OF CONTRACT DOCUMENTS.....</b>	<b>F56</b>
<b>ARTICLE 66 - NOTICE OF TAXABLE POSSESSORY .....</b>	<b>F56</b>
<b>ARTICLE 67 - SURVIVAL OF OBLIGATIONS.....</b>	<b>F56</b>

**GENERAL CONDITIONS**  
**SECTION F- LABOR AND CONSTRUCTION**

**ARTICLE 1    DEFINITIONS**

Whenever used in the Contract Documents and printed with initial capital letters, the terms listed below will have the meanings indicated which are applicable to both the singular and plural thereof. In addition to terms specifically defined below, terms with initial capital letters in the Contract Documents include references to identified articles and paragraphs, and the titles of other documents or forms.

- A. Act of God – An earthquake of magnitude of 3.5 or higher on the Richter scale or a tidal wave.
- B. Addenda -- Written or graphic instruments issued prior to the submission of Bids which clarify, correct, or change the Contract Documents.
- C. Additional Work -- New or unforeseen work will be classified as “Additional Work” when the District’s Representative determines that it is not covered by the Contract.
- D. Applicable Laws -- The laws, statutes, ordinances, rules, codes, regulations, permits, and licenses of any kind, issued by local, state or federal governmental authorities or private authorities with jurisdiction (including utilities), to the extent they apply to the Work.
- E. Bid -- The offer or proposal of a Bidder submitted on the prescribed form setting forth the prices and other terms for the Work to be performed.
- F. Bidder -- The individual or entity who submits a Bid directly to the District.
- G. Change Order (“CO”) -- A document that authorizes an addition, deletion, or revision in the Work or an adjustment in the Contract Price or the Contract Times, issued on or after the Effective Date of the Contract, in accordance with the Contract Documents and in the form contained in the Contract Documents.
- H. Change Order Request (“COR”) -- A request made by the Contractor for an adjustment in the Contract Price and/or Contract Times as the result of a Contractor-claimed change to the Work. This term may also be referred to as a Change Order Proposal (“COP”), or Request for Change (“RFC”).
- I. District -- The Valley-Wide Recreation and Park District.
- J. District Board, Board -- The Board of Directors of the District.
- K. District’s Representative -- The individual or entity as identified in the Special Conditions to act as the District’s Representative.
- L. Claim -- A demand or assertion by the District or Contractor seeking an adjustment of Contract Price or Contract Times, or both, or other relief with respect to the terms of the Contract. A demand for money or services by a third party is not a Claim.
- M. Contract -- The entire integrated written agreement between the District and Contractor concerning the Work. “Contract” may be used interchangeably with

**GENERAL CONDITIONS**  
**SECTION F- LABOR AND CONSTRUCTION**

“Agreement” in the Contract Documents. The Contract supersedes prior negotiations, representations, or agreements, whether written or oral, and includes all Contract Documents.

- N. Contract Documents -- The documents listed in Section 00 52 13, Article 5. Some documents provided by the District to the Bidders and Contractor, including but not limited to reports and drawings of subsurface and physical conditions are not Contract Documents.
- O. Contract Price -- Amount to be paid by the District to the Contractor as full compensation for the performance of the Contract and completion of the Work, subject to any additions or deductions as provided in the Contract Documents, and including all applicable taxes and costs.
- P. Contract Times -- The number of days or the dates stated in the Contract Documents to: achieve defined Milestones, if any; and to complete the Work so that it is ready for final payment.
- Q. Contractor -- The individual or entity with which the District has contracted for performance of the Work.
- R. Contractor’s Designated On-Site Representative -- The Contractor’s Designated On-Site Representative will be as identified in Section 00 72 13, Article 3 and shall not be changed without prior written consent of the District.
- S. Daily Rate -- The Daily Rate stipulated in the Contract Documents as full compensation to the Contractor due to the District’s unreasonable delay to the Project that was not contemplated by the parties.
- T. Day -- A calendar day of 24 hours measured from midnight to the next midnight.
- U. Defective Work -- Work that is unsatisfactory, faulty, or deficient; or that does not conform to the Contract Documents; or that does not meet the requirements of any inspection, reference standard, test, or approval referenced in the Contract Documents.
- V. Demobilization -- The complete dismantling and removal by the Contractor of all of the Contractor’s temporary facilities, equipment, and personnel at the Site.
- W. Drawings -- That part of the Contract Documents prepared by of the Engineer of Record which graphically shows the scope, extent, and character of the Work to be performed by Contractor. Shop Drawings and other Contractor submittals are not Drawings as so defined.
- X. Effective Date of the Contract -- The date indicated in the Contract on which it becomes effective, but if no such date is indicated, it means the date on which the Contract is signed and delivered by the last of the two parties to sign and deliver.
- Y. Engineer, whenever not qualified, shall mean the General Manager of the District, acting either directly or through properly authorized agents, such agents acting



**GENERAL CONDITIONS**  
**SECTION F- LABOR AND CONSTRUCTION**

severally within the scope of the particular duties entrusted to them. On all questions concerning the acceptance of materials, machinery, the classifications of material, the execution of work, conflicting interest of the contractors performing related work and the determination of costs, the decision of the Engineer, duly authorized by the District Board, shall be binding and final upon both parties.

Z. Engineer of Record -- The individual, partnership, corporation, joint venture, or other legal entity named as such in Section 00 73 13, Article 1.1. or any succeeding entity designated by the District.

AA. Green Book -- The current edition of the Standard Specifications for Public Works Construction promulgated by the Joint Cooperative Committee of the Southern California Chapter American Public Works Association and the Southern California Districts of the Associated General Contractors of California.

BB. Hazardous Waste -- The term "Hazardous Waste" shall have the meaning provided in Section 104 of the Solid Waste Disposal Act (42 U.S.C. § 6903) as amended from time to time or, as defined in Section 25117 of the Health and Safety Code, that is required to be removed to a class I, class II, or class III disposal site in accordance with provisions of existing law, whichever is more restrictive.

CC. Holiday – The Holidays occur on:

New Year's Day - January 1  
President's Day – Third Monday in February  
Memorial Day - Last Monday in May  
Independence Day - July 4  
Labor Day - First Monday in September  
Veteran's Day - November 11  
Thanksgiving Day - Fourth Thursday in November  
Friday after Thanksgiving  
Christmas Eve – December 24  
Christmas Day - December 25  
Day After Christmas – December 26  
New Year's Eve – December 31

If any Holiday listed above falls on a Saturday, Saturday and the preceding Friday are both Holidays. If the Holiday should fall on a Sunday, Sunday and the following Monday are both Holidays.

DD. Notice of Award -- The written notice by the District to the Successful Bidder stating that upon timely compliance by the Successful Bidder with the conditions precedent listed therein, the District will sign and deliver the Contract.

EE. Notice of Completion -- The form which may be executed by the District and recorded by the county where the Project is located constituting final acceptance of the Project.

**GENERAL CONDITIONS**  
**SECTION F- LABOR AND CONSTRUCTION**

- FF. Notice to Proceed -- A written notice given by the District to Contractor fixing the date on which the Contractor may proceed with the Work and when Contract Times will commence to run.
- GG. Project -- The total construction of which the Work to be performed under the Contract Documents may be the whole, or a part.
- HH. Recyclable Waste Materials -- Materials removed from the Site which are required to be diverted to a recycling center rather than an area landfill. Recyclable Waste Materials include asphalt, concrete, brick, concrete block, and rock.
- II. Schedule of Submittals -- A schedule, prepared and maintained by Contractor, of required submittals and the time requirements to facilitate scheduled performance of related construction activities.
- JJ. Shop Drawings -- All drawings, diagrams, illustrations, schedules, and other data or information which are specifically prepared or assembled by or for Contractor and submitted by Contractor to illustrate some portion of the Work.
- KK. Specifications -- That part of the Contract Documents consisting of written requirements for materials, equipment, systems, standards and workmanship as applied to the Work, and certain administrative requirements and procedural matters applicable thereto.
- LL. Stop Payment Notice -- A written notice as defined in Civil Code section 8044.
- MM. Subcontractor -- An individual or entity other than a Contractor having a contract with any other entity than the District for performance of any portion of the Work at the Site.
- NN. Submittal -- Written and graphic information and physical samples prepared and supplied by the Contractor demonstrating various portions of the Work.
- OO. Successful Bidder -- The Bidder submitting a responsive Bid to whom the District makes an award.
- PP. Supplier -- A manufacturer, fabricator, supplier, distributor, material man, or vendor having a direct contract with Contractor or with any Subcontractor to furnish materials or equipment used in the performance of the Work or to be incorporated in the Work.
- QQ. Underground Facilities -- All underground pipelines, conduits, ducts, cables, wires, manholes, vaults, tanks, tunnels, or other such facilities or attachments, and any encasements containing such facilities, including those that convey electricity, gases, steam, liquid petroleum products, telephone or other communications, cable television, water, wastewater, storm water, other liquids or chemicals, or traffic or other control systems.

**GENERAL CONDITIONS**  
**SECTION F- LABOR AND CONSTRUCTION**

- RR. Unit Price Work -- Work to be paid for on the basis of unit prices as provided by the Contractor in its bid or as adjusted in accordance with the Contract Documents.
- SS. Warranty -- A written guarantee provided to the District by the Contractor that the Work will remain free of defects and suitable for its intended use for the period required by the Contract Documents or the longest period permitted by the law of this State, whichever is longer.
- TT. Work -- The entire construction or the various separately identifiable parts thereof required to be provided under the Contract Documents. Work includes and is the result of performing or providing all labor, services, and documentation necessary to produce such construction, and furnishing, installing, and incorporating all materials and equipment into such construction, all as required by the Contract Documents.

**ARTICLE 2 CONTRACT DOCUMENTS**

- A. **Contract Documents.** The Contract Documents are complementary, and what is called for by one shall be as binding as if called for by all.
- B. **Interpretations.** The Contract Documents are intended to be fully cooperative and complementary. If the Contractor observes that any documents are in conflict, the Contractor shall promptly notify the Engineer in writing. In case of conflicts between the Contract Documents, the order of precedence shall be as follows:

Change Orders

1. Addenda
2. Special Conditions
3. Technical Specifications
4. Plans (Contract Drawings)
5. Contract
6. General Conditions
7. Instructions to Bidders
8. Notice Inviting Bids
9. Contractor's Bid Forms
10. Standard Specifications for Public Works Construction (Sections 1-9 Excluded)
11. Applicable Local Agency Standards and Specifications
12. Standard Drawings
13. Reference Documents

With reference to the Drawings, the order of precedence shall be as follows:

1. Figures govern over scaled dimensions
2. Detail drawings govern over general drawings
3. Addenda or Change Order drawings govern over Contract Drawings
4. Contract Drawings govern over Standard Drawings
5. Contract Drawings govern over Shop Drawings

**GENERAL CONDITIONS**  
**SECTION F- LABOR AND CONSTRUCTION**

- C. **Conflicts in Contract Documents.** Notwithstanding the orders of precedence established above, in the event of conflicts, the higher standard, higher quality, and most expensive shall always apply.
- D. **Organization of Contract Documents.** Organization of the Contract Documents into divisions, sections, and articles, and arrangement of drawings shall not control the Contractor in dividing Project Work among subcontractors or in establishing the extent of Work to be performed by any trade.

**ARTICLE 3 PRECONSTRUCTION AND CONSTRUCTION COMMUNICATION**

Before any Work at the site is started, a conference attended by the District, Contractor, District's Representative, and others as appropriate will be held to establish a working understanding among the parties as to the Work and to discuss the schedules referred to herein, procedures for handling Shop Drawings and other submittals, processing Applications for Payment, and maintaining required records.

At this conference the District and Contractor each shall designate, in writing, a specific individual to act as its authorized representative with respect to the services and responsibilities under the Contract. Such individuals shall have the authority to transmit instructions, receive information, render decisions relative to the Contract, and otherwise act on behalf of each respective party.

**ARTICLE 4 CONTRACT DOCUMENTS: COPIES & MAINTENANCE**

Contractor will be furnished, free of charge, **two (2)** copies of the Contract Documents. Additional copies may be obtained at cost of reproduction.

Contractor shall maintain a clean, undamaged set of Contract Documents, including submittals, at the Project site.

**ARTICLE 5 EXAMINATION OF DRAWINGS, SPECIFICATIONS AND SITE OF WORK**

- A. **Examination of Contract Documents.** Before commencing any portion of the Work, Contractor shall again carefully examine all applicable Contract Documents, the Project site, and other information given to Contractor as to materials and methods of construction and other Project requirements. Contractor shall immediately notify the Engineer of any potential error, inconsistency, ambiguity, conflict, or lack of detail or explanation. If Contractor performs, permits, or causes the performance of any Work which is in error, inconsistent or ambiguous, or not sufficiently detailed or explained, Contractor shall bear any and all resulting costs, including, without limitation, the cost of correction. In no case shall the Contractor or any subcontractor proceed with Work if uncertain as to the applicable requirements.
- B. **Additional Instructions.** After notification of any error, inconsistency, ambiguity, conflict, or lack of detail or explanation, the Engineer will provide any required additional instructions, by means of drawings or other written direction, necessary for proper execution of Work.

**GENERAL CONDITIONS**  
**SECTION F- LABOR AND CONSTRUCTION**

- C. **Quality of Parts, Construction and Finish.** All parts of the Work shall be of the best quality of their respective kinds and the Contractor must use all diligence to inform itself fully as to the required construction and finish.
- D. **Contractor's Variation from Contract Document Requirements.** If it is found that the Contractor has varied from the requirements of the Contract Documents including the requirement to comply with all applicable laws, ordinances, rules and regulations, the Engineer may at any time, before or after completion of the Work, order the improper Work removed, remade or replaced by the Contractor at the Contractor's expense.

**ARTICLE 6 MOBILIZATION**

- A. When a bid item is included in the Bid Form for mobilization, the costs of Work in advance of construction operations and not directly attributable to any specific bid item will be included in the progress estimate ("Initial Mobilization"). When no bid item is provided for "Initial Mobilization," payment for such costs will be deemed to be included in the other items of the Work.
- B. Payment for Initial Mobilization based on the lump sum provided in the Bid Form, which shall constitute full compensation for all such Work. No payment for Initial Mobilization will be made until all of the listed items have been completed to the satisfaction of the Engineer. The scope of the Work included under Initial Mobilization shall include, but shall not be limited to, the following principal items:
  - 1. Obtaining and paying for all bonds, insurance, and permits.
  - 2. Moving on to the Project site of all Contractor's plant and equipment required for the first month's operations.
  - 3. Installing temporary construction power, wiring, and lighting facilities, as applicable.
  - 4. Establishing fire protection system, as applicable.
  - 5. Developing and installing a construction water supply, if applicable.
  - 6. Providing and maintaining the field office trailers for the Contractor, if necessary, and the Engineer (if specified), complete, with all specified furnishings and utility services.
  - 7. Providing on-site sanitary facilities and potable water facilities as specified per Cal-OSHA and these Contract Documents.
  - 8. Furnishing, installing, and maintaining all storage buildings or sheds required for temporary storage of products, equipment, or materials that have not yet been installed in the Work. All such storage shall meet manufacturer's specified storage requirements, and the specific provisions of the specifications, including temperature and humidity control, if recommended by the manufacturer, and for all security.

**GENERAL CONDITIONS**  
**SECTION F- LABOR AND CONSTRUCTION**

9. Arranging for and erection of Contractor's work and storage yard.
10. Posting all OSHA required notices and establishment of safety programs per Cal-OSHA.
11. Full-time presence of Contractor's superintendent at the job site as required herein.
12. Submittal of Construction Schedule as required by the Contract Documents.

**ARTICLE 7 EXISTENCE OF UTILITIES AT THE WORK SITE**

- A. The District has endeavored to determine the existence of utilities at the Project site from the records of the owners of known utilities in the vicinity of the Project. The positions of these utilities as derived from such records are shown on the Plans.
- B. Unless indicated otherwise on the Plans and Specifications, no excavations were made to verify the locations shown for underground utilities. The service connections to these utilities are not shown on the Plans. Water service connections may be shown on the Plans showing general locations of such connections. It shall be the responsibility of the Contractor to determine the exact location of all service connections. The Contractor shall make its own investigations, including exploratory excavations, to determine the locations and type of service connections, prior to commencing Work which could result in damage to such utilities. The Contractor shall immediately notify the District in writing of any utility discovered in a different position than shown on the Plans or which is not shown on the Plans.
- C. If applicable, all water meters, water valves, fire hydrants, electrical utility vaults, telephone vaults, gas utility valves, and other subsurface structures shall be relocated or adjusted to final grade by the Contractor. Locations of existing utilities shown on the Plans are approximate and may not be complete. The Contractor shall be responsible for coordinating its Work with all utility companies during the construction of the Work.
- D. Notwithstanding the above, pursuant to section 4215 of the Government Code, the District has the responsibility to identify, with reasonable accuracy, main or trunk line facilities on the plans and specifications. In the event that main or trunk line utility facilities are not identified with reasonable accuracy in the plans and specifications made a part of the invitation for Bids, the District shall assume the responsibility for their timely removal, relocation, or protection.
- E. Contractor, except in an emergency, shall contact the appropriate regional notification center, **Southern California Underground Service Alert** at 811 or 1-800-227-2600 or on-line at [www.digalert.org](http://www.digalert.org) at least two working days prior to commencing any excavation if the excavation will be performed in an area which is known, or reasonably should be known, to contain subsurface installations other than the underground facilities owned or operated by the District, and obtain an inquiry identification number from that notification center. No

**GENERAL CONDITIONS**  
**SECTION F- LABOR AND CONSTRUCTION**

excavation shall be commenced or carried out by the Contractor unless such an inquiry identification number has been assigned to the Contractor or any subcontractor of the Contractor and the District has been given the identification number by the Contractor.

**ARTICLE 8 SOILS INVESTIGATIONS**

- A. Reports and Drawings. The Special Conditions identify:
1. those reports known to the District of explorations and tests of subsurface conditions at or contiguous to the site; and
  2. those drawings known to the District of physical conditions relating to existing surface or subsurface structures at the site (except Underground Facilities).
- B. Limited Reliance by Contractor on Technical Data Authorized. Contractor may rely upon the accuracy of the "technical data" contained in such reports and drawings, which were expressly not created or obtained to evaluate or assist in the evaluation of constructability, and are not Contract Documents. Contractor shall make its own interpretation of the "technical data" and shall be solely responsible for any such interpretations. Except for reliance on the accuracy of such "technical data," Contractor may not rely upon or make any claim against the District, District's Representative, or Engineer of Record, or any of their officers, directors, members, partners, employees, agents, consultants, or subcontractors, with respect to:
1. the completeness of such reports and drawings for Contractor's purposes, including without limitation any aspects of the means, methods, techniques, sequences, and procedures of construction to be employed by Contractor, and safety precautions and programs incident thereto; or
  2. other data, interpretations, opinions, conclusions and information contained in such reports or shown or indicated in such drawings; or
  3. any Contractor interpretation of or conclusion drawn from any "technical data" or any such other data, interpretations, opinions, or information.

**ARTICLE 9 CONTRACTOR'S SUPERVISION**

Contractor shall continuously keep at the Project site, a competent and experienced full-time Project superintendent acceptable to the District. Superintendent must be able to proficiently speak, read and write in English and shall have the authority to make decisions on behalf of the Contractor. Contractor shall continuously provide efficient supervision of the Project.

**ARTICLE 10 WORKERS**

- A. Contractor shall at all times enforce strict discipline and good order among its employees. Contractor shall not employ on the Project any unfit person or any one not skilled in the Work assigned to him or her.

**GENERAL CONDITIONS**  
**SECTION F- LABOR AND CONSTRUCTION**

- B. Any person in the employ of the Contractor whom the District may deem incompetent or unfit shall be dismissed from the Work and shall not be employed on this Project.

**ARTICLE 11 INDEPENDENT CONTRACTORS**

Contractor shall be an independent contractor for the District and not an employee. Contractor understands and agrees that it and all of its employees shall not be considered officers, employees, or agents of District and are not entitled to benefits of any kind normally provided employees of District, including but not limited to, state unemployment compensation or workers' compensation. Contractor assumes full responsibility for the acts and omissions of its employees or agents related to the Work.

**ARTICLE 12 SUBCONTRACTS**

- A. Contractor agrees to bind every subcontractor to the terms of the Contract Documents as far as such terms are applicable to subcontractor's portion of the Work. Contractor shall be as fully responsible to the District for the acts and omissions of its subcontractors and of persons either directly or indirectly employed by its subcontractors, as Contractor is for acts and omissions of persons directly employed by Contractor. Nothing contained in these Contract Documents shall create any contractual relationship between any subcontractor and the District.
- B. The District reserves the right to accept all subcontractors. The District's acceptance of any subcontractor under this Contract shall not in any way relieve Contractor of its obligations in the Contract Documents.
- C. Prior to substituting any subcontractor listed in the Bid Forms, Contractor must comply with the requirements of the Subletting and Subcontracting Fair Practices Act pursuant to California Public Contract Code section 4100 et seq.

**ARTICLE 13 VERIFICATION OF EMPLOYMENT ELIGIBILITY**

By executing this Contract, Contractor verifies that it fully complies with all requirements and restrictions of state and federal law respecting the employment of undocumented aliens, including, but not limited to, the Immigration Reform and Control Act of 1986, as may be amended from time to time, and shall require all subcontractors, sub-subcontractors and consultants to comply with the same. Each person executing this Contract on behalf of Contractor verifies that he or she is a duly authorized officer of Contractor and that any of the following shall be grounds for the District to terminate the Contract for cause: (1) failure of the Contractor or its subcontractors, sub-subcontractors or consultants to meet any of the requirements provided for in this Article; (2) any misrepresentation or material omission concerning compliance with such requirements; or (3) failure to immediately remove from the Work any person found not to be in compliance with such requirements.

**ARTICLE 14 REQUESTS FOR SUBSTITUTION**

- A. For the purposes of this provision, the term "substitution" shall mean the substitution of any material, method or service substantially equal to or better in



**GENERAL CONDITIONS**  
**SECTION F- LABOR AND CONSTRUCTION**

every respect to that indicated in the Standard Specifications or otherwise referenced herein.

- B. Pursuant to Public Contract Code section 3400(b), the District may make a finding that is described in the Notice Inviting Bids that designates certain products, things, or services by specific brand or trade name.
- C. Unless specifically designated in the Special Conditions, whenever any material, process, or article is indicated or specified by grade, patent, or proprietary name or by name of manufacturer, such specifications shall be deemed to be used for the purpose of facilitating the description of the material, process, or article desired and shall be deemed to be followed by the words "or equal." Contractor may, unless otherwise stated, offer for substitution any material, process, or article which may be substantially equal to or better in every respect to that so indicated or specified in the Contract Documents. However, the District has adopted uniform standards for certain materials, processes, and articles.
- D. The Contractor shall submit substitution requests, together with substantiating data, for substitution of any "or equal" material, process, or article no later than thirty-five (35) calendar days after award of Contract. Provisions regarding submission of substitution requests shall not in any way authorize an extension of time for the performance of this Contract. If a substitution request is rejected by the District, the Contractor shall provide the material, method or service specified herein. The District shall not be responsible for any costs incurred by the Contractor associated with substitution requests. The burden of proof as to the equality of any material, process, or article shall rest with the Contractor. The Engineer has the complete and sole discretion to determine if a material, process, or article is substantially equal to or better than that specified and to approve or reject all substitution requests.
- E. Substantiating data as described above shall include, at a minimum, the following information:
  - 1. A signed affidavit from the Contractor stating that the material, process, or article proposed as a substitution is substantially equal to or better than that specified in every way except as may be listed on the affidavit.
  - 2. Illustrations, specifications, catalog cut sheets, and any other relevant data required to prove that the material, process, or article is substantially equal to or better than that specified.
  - 3. A statement of the cost implications of the substitution being requested, indicating whether and why the proposed substitution will reduce or increase the amount of the contract.
  - 4. Information detailing the durability and lifecycle costs of the proposed substitution.
- F. Failure to submit all the required substantiating data detailed above in a timely manner so that the substitution request can be adequately reviewed may result

**GENERAL CONDITIONS**  
**SECTION F- LABOR AND CONSTRUCTION**

in rejection of the substitution request. The Engineer is not obligated to review multiple submittals related the same substitution request resulting from the Contractor's failure to initially submit a complete package.

- G. Time limitations within this Article shall be strictly complied with and in no case will an extension of time for completion of the contract be granted because of Contractor's failure to provide substitution requests at the time and in the manner described herein.
- H. The Contractor shall bear the costs of all District work associated with the review of substitution requests.
- I. If substitution requests approved by the Engineer require that Contractor furnish materials, methods or services more expensive than that specified, the increased costs shall be borne by Contractor.

**ARTICLE 15 SHOP DRAWINGS**

- A. Contractor shall check and verify all field measurements and shall submit with such promptness as to provide adequate time for review and cause no delay in its own Work or in that of any other contractor, subcontractor, or worker on the Project, six (6) copies of all shop drawings, calculations, schedules, and materials list, and all other provisions required by the Contract Documents. Contractor shall sign all submittals affirming that submittals have been reviewed and approved by Contractor prior to submission to Engineer. Each signed submittal shall affirm that the submittal meets all the requirements of the Contract Documents except as specifically and clearly noted and listed on the transmittal letter of the submittal.
- B. Contractor shall make any corrections required by the Engineer, and file with the Engineer six (6) corrected copies each, and furnish such other copies as may be needed for completion of the Work. Engineer's acceptance of shop drawings shall not relieve Contractor from responsibility for deviations from the Contract Documents unless Contractor has, in writing, called Engineer's attention to such deviations at time of submission and has secured the Engineer's written acceptance. Engineer's acceptance of shop drawings shall not relieve Contractor from responsibility for errors in shop drawings.

**ARTICLE 16 SUBMITTALS**

- A. Contractor shall furnish to the Engineer for approval, prior to purchasing or commencing any Work, a log of all samples, material lists and certifications, mix designs, schedules, and other submittals, as required in the Contract Documents. The log shall indicate whether samples will be provided in accordance with other provisions of this Contract.
- B. Contractor will provide samples and submittals, together with catalogs and supporting data required by the Engineer, to the Engineer within a reasonable time period to provide for adequate review and avoid delays in the Work.

**GENERAL CONDITIONS**  
**SECTION F- LABOR AND CONSTRUCTION**

- C. These requirements shall not authorize any extension of time for performance of this Contract. Engineer will check and approve such samples, but only for conformance with design concept of work and for compliance with information given in the Contract Documents. Work shall be in accordance with approved samples and submittals.

**ARTICLE 17 MATERIALS**

- A. Except as otherwise specifically stated in the Contract Documents, Contractor shall provide and pay for all materials, labor, tools, equipment, lights, power, transportation, superintendence, temporary constructions of every nature, and all other services and facilities of every nature whatsoever necessary to execute and complete this Contract within specified time.
- B. Unless otherwise specified, all materials shall be new and the best of their respective kinds and grades as noted and/or specified, and workmanship shall be of good quality.
- C. Materials shall be furnished in ample quantities and at such times as to ensure uninterrupted progress of the Work and shall be stored properly and protected as required by the Contract Documents. Contractor shall be entirely responsible for damage or loss by weather or other causes to materials or Work.
- D. No materials, supplies, or equipment for Work under this Contract shall be purchased subject to any chattel mortgage or under a conditional sale or other agreement by which an interest therein or in any part thereof is retained by the seller or supplier. Contractor warrants good title to all material, supplies, and equipment installed or incorporated in the Work and agrees upon completion of all work to deliver the Project, to the District free from any claims, liens, or charges.
- E. Materials shall be stored on the Project site in such manner so as not to interfere with any operations of the District or any independent contractor.
- F. Contractor shall verify all measurements, dimensions, elevations, and quantities before ordering any materials or performing any Work, and the District shall not be liable for Contractor's failure to so. No additional compensation, over and above payment for the actual quantities at the prices set out in the Bid Form, will be allowed because of differences between actual measurements, dimension, elevations and quantities and those indicated on the Plans and in the Specifications. Any difference therein shall be submitted to the Engineer for consideration before proceeding with the Work.

**ARTICLE 18 PERMITS AND LICENSES**

- A. District will apply and pay for the review of necessary encroachment permits for Work within the public rights-of-way. Contractor shall obtain all other necessary permits and licenses for the construction of the Project, including encroachment permits, and shall pay all fees required by law and shall comply with all laws, ordinances, rules and regulations relating to the Work and to the preservation of

**GENERAL CONDITIONS**  
**SECTION F- LABOR AND CONSTRUCTION**

public health and safety. Before acceptance of the Project, the Contractor shall submit all licenses, permits, certificates of inspection and required approvals to the District.

- B. The Bid Form contains an allowance for the Contractor's cost of acquiring traffic control permits and for construction inspection fees that may be charged to the Contractor by the Agency of Jurisdiction. The allowance is included within the Bid Form to eliminate the need by bidders to research or estimate the costs of traffic control permits and construction inspection fees prior to submitting a bid. The allowance is specifically intended to account for the costs of traffic control permits and construction inspection fees charged by the local Agency of Jurisdiction only. No other costs payable by Contractor to the Agency of Jurisdiction are included within the allowance. Payment by District to Contractor under the Permit and Inspection Allowance Bid Item shall be made based on actual cost receipts only and in accordance with the provisions of these specifications.

**ARTICLE 19 TRENCHES**

- A. Trenches Five Feet or More in Depth.** Contractor shall submit to the Engineer at the preconstruction meeting, a detailed plan showing the design of shoring, bracing, sloping or other provisions to be made for worker protection from hazards of caving ground during the excavation of any trench or trenches five feet or more in depth. If such plan varies from shoring system standards established by the Construction Safety Orders of the California Code of Regulations, Department of Industrial Relations, the plan shall be prepared by a California registered civil or structural engineer. The plan shall not be less effective than the shoring, bracing, sloping, or other provisions of the Construction Safety Orders, as defined in the California Code of Regulations. The Contractor shall designate in writing the "competent person" as defined in Title 8, California Code of Regulations, who shall be present at the Work Site each day that trenching/excavation is in progress. The "competent person" shall prepare and provide daily trenching/excavation inspection reports to the Engineer. Contractor shall also submit a copy of its annual California Occupational Safety and Health Administration (Cal/OSHA) trench/excavation permit.
- B. Excavations Deeper than Four Feet.** If the Work involves excavating trenches or other excavations that extend deeper than four feet below the surface, Contractor shall promptly, and before the excavation is further disturbed, notify the District in writing of any of the following conditions:
- C. Material that the Contractor believes may be material that is hazardous waste, as defined in section 25117 of the Health and Safety Code, that is required to be removed to a Class I, Class II, or Class III disposal site in accordance with provisions of existing law.
1. Subsurface or latent physical conditions at the site differing from those indicated.

**GENERAL CONDITIONS**  
**SECTION F- LABOR AND CONSTRUCTION**

2. Unknown physical conditions at the site of any unusual nature, different materially from those ordinarily encountered and generally recognized as inherent in work of the character provided for in the Contract

The District shall promptly investigate the conditions, and if it finds that the conditions do so materially differ, or do involve hazardous waste, and cause a decrease or increase in Contractor's cost of, or the time required for, performance of any part of the Work, shall issue a change order under the procedures described in the Contract Documents.

In the event that a dispute arises between the District and the Contractor as to whether the conditions materially differ, or involve hazardous waste, or cause a decrease or increase in the Contractor's cost of, or time required for, performance of any part of the Work, the Contractor shall not be excused from any scheduled completion date provided for by the Contract, but shall proceed with all Work to be performed under the Contract. Contractor shall retain any and all rights provided either by contract or by law which pertain to the resolution of disputes and protests between the parties.

**ARTICLE 20 TRAFFIC CONTROL**

- A. Traffic control plan(s) for the Work may be required by the Agency(s) of Jurisdiction. Traffic control plans, if required, shall be prepared at Contractor's expense, and traffic control shall be performed at Contractor's expense in accordance with the requirements of the Agency(s) of Jurisdiction. The Permit and Inspection Allowance included within the Bid Form includes the cost of required traffic control permit(s) and construction inspection by the Agency(s) of Jurisdiction only. The Permit and Inspection Allowance does not include costs for preparation of any required traffic control plans, implementation of any traffic control requirements or for any traffic signal services that may be required. Costs for traffic control plans, implementation of traffic control, or traffic signal services required by the Agency(s) of Jurisdiction shall be included in the Contractor's Bid.
- B. All warning signs and safety devices used by the Contractor to perform the Work shall conform to the requirements contained in the State of California, Department of Transportation's current edition of "Manual of Traffic Controls for Construction and Maintenance Work Zones" or to the requirements of the local agency. The Contractor shall also be responsible for all traffic control required by the agency having jurisdiction over the project on the intersecting streets. Contractor must submit a traffic control plan to the agency having jurisdiction over the project for approval prior to starting work.
- C. The Contractor's representative on the site responsible for traffic control shall produce evidence that he/she has completed training acceptable to the California Department of Transportation for safety through construction zones. All of the streets in which the Work will occur shall remain open to traffic and one lane of traffic maintained at all times unless otherwise directed by the agency of jurisdiction. Businesses and residences adjacent to the Work shall be notified forty-eight (48) hours in advance of closing of driveways. The Contractor

**GENERAL CONDITIONS**  
**SECTION F- LABOR AND CONSTRUCTION**

shall make every effort to minimize the amount of public parking temporarily eliminated due to construction in areas fronting businesses. No stockpiles of pipe or other material will be allowed in traveled right-of-ways after working hours unless otherwise approved by the Engineer.

**ARTICLE 21 DIVERSION OF RECYCLABLE WASTE MATERIALS**

In compliance with the applicable District's waste reduction and recycling efforts, Contractor shall divert all Recyclable Waste Materials to appropriate recycling centers as required for compliance with the local jurisdiction's waste diversion ordinances. Contractor will be required to submit weight tickets and written proof of diversion with its monthly progress payment requests. Contractor shall complete and execute any certification forms required by District or other applicable agencies to document Contractor's compliance with these diversion requirements. All costs incurred for these waste diversion efforts shall be the responsibility of the Contractor.

**ARTICLE 22 REMOVAL OF HAZARDOUS MATERIALS**

Should Contractor encounter material reasonably believed to be polychlorinated biphenyl (PCB) or other toxic wastes and hazardous materials which have not been rendered harmless at the Project site, the Contractor shall immediately stop work at the affected Project site and shall report the condition to the District in writing. The District shall contract for any services required to directly remove and/or abate PCBs and other toxic wastes and hazardous materials, if required by the Project site(s), and shall not require the Contractor to subcontract for such services. The Work in the affected area shall not thereafter be resumed except by written agreement of the District and Contractor.

**ARTICLE 23 SANITARY FACILITIES**

Contractor shall provide sanitary temporary toilet buildings and hand washing facilities for the use of all workers. All toilets and hand washing facilities shall comply with local codes and ordinances. Toilets shall be kept supplied with toilet paper and shall have workable door fasteners. Toilets and hand washing facilities shall be serviced no less than once weekly and shall be present in a quantity of not less than 1 per 20 workers as required by Cal/OSHA regulations. The toilets and hand washing facilities shall be maintained in a sanitary condition at all times. Use of toilet and hand washing facilities in the Work under construction shall not be permitted. Any other Sanitary Facilities required by Cal/OSHA shall be the responsibility of the Contractor.

**ARTICLE 24 AIR POLLUTION CONTROL**

Contractor shall comply with all air pollution control rules, regulations, ordinances and statutes, including, but not limited to, those required by the South Coast Air Quality Management District. All containers of paint, thinner, curing compound, solvent or liquid asphalt shall be labeled to indicate that the contents fully comply with the applicable material requirements.

**ARTICLE 25 LAYOUT AND FIELD ENGINEERING**

All field engineering required for laying out the Work and establishing grades for earthwork operations shall be furnished by the Contractor at its expense.

**GENERAL CONDITIONS**  
**SECTION F- LABOR AND CONSTRUCTION**

**ARTICLE 26 TESTS AND INSPECTIONS**

- A. If the Contract Documents, the Engineer, or any instructions, laws, ordinances, or public authority requires any part of the Work to be tested or Approved, Contractor shall provide the Engineer at least two (2) working days' notice of its readiness for observation or inspection. If inspection is by a public authority other than the District, Contractor shall promptly inform the District of the date fixed for such inspection. Required certificates of inspection (or similar) shall be secured by Contractor. Costs for District testing and District inspection shall be paid by the District. Costs of tests for Work found not to be in compliance shall be paid by the Contractor.
- B. If any Work is done or covered up without the required testing or approval, the Contractor shall uncover or deconstruct the Work, and the Work shall be redone after completion of the testing at the Contractor's cost in compliance with the Contract Documents.
- C. Where inspection and testing are to be conducted by an independent laboratory or agency, materials or samples of materials to be inspected or tested shall be selected by such laboratory or agency, or by the District, and not by Contractor. All tests or inspections of materials shall be made in accordance with the commonly recognized standards of national organizations.
- D. In advance of manufacture of materials to be supplied by Contractor which must be tested or inspected, Contractor shall notify the District so that the District may arrange for testing at the source of supply. Any materials which have not satisfactorily passed such testing and inspection shall not be incorporated into the Work.
- E. If the manufacture of materials to be inspected or tested will occur in a plant or location greater than sixty (60) miles from the District, the Contractor shall pay for any excessive or unusual costs associated with such testing or inspection, including but not limited to excessive travel time, standby time and required lodging.
- F. Reexamination of Work may be ordered by the District. If so ordered, Work must be uncovered or deconstructed by Contractor. If Work is found to be in accordance with the Contract Documents, the District shall pay the costs of reexamination and reconstruction. If such work is found not to be in accordance with the Contract Documents, Contractor shall pay all costs.

**ARTICLE 27 PROTECTION OF WORK AND PROPERTY**

- A. The Contractor shall be responsible for all damages to persons or property that occurs as a result of the Work. Contractor shall be responsible for the proper care and protection of all materials delivered and Work performed until completion and final Acceptance by the District. All Work shall be solely at the Contractor's risk. Contractor shall adequately protect adjacent property from settlement or loss of lateral support as necessary. Contractor shall comply with all applicable safety laws and building codes to prevent accidents or injury to

**GENERAL CONDITIONS**  
**SECTION F- LABOR AND CONSTRUCTION**

persons on, about, or adjacent to the Project site where Work is being performed. Contractor shall erect and properly maintain at all times, as required by field conditions and progress of work, all necessary safeguards, signs, barriers, lights, and watchmen for protection of workers and the public, and shall post danger signs warning against hazards created in the course of construction.

- B. In an emergency affecting safety of life or of work or of adjoining property, Contractor, without special instruction or authorization from the Engineer, is hereby permitted to act to prevent such threatened loss or injury; and Contractor shall so act, without appeal, if so authorized or instructed by the Engineer or the District. Any compensation claimed by Contractor on account of emergency work shall be determined by and agreed upon by the District and the Contractor.

**ARTICLE 28 CONTRACTOR'S MEANS AND METHODS**

Contractor is solely responsible for the means and methods utilized to perform the Work. In no case shall the Contractor's means and methods deviate from commonly used industry standards.

**ARTICLE 29 AUTHORIZED REPRESENTATIVES**

The District shall designate representatives, who shall have the right to be present at the Project site at all times. The District may designate an inspector who shall have the right to observe all of the Contractor's Work. The inspector shall not be responsible for the Contractor's failure to carry out the Work in accordance with the Contract Documents. Contractor shall provide safe and proper facilities for such access.

**ARTICLE 30 HOURS OF WORK**

- A. As provided in Article 3 (commencing at section 1810), Chapter 1, Part 7, Division 2 of the Labor Code, Contractor stipulates that eight (8) hours of labor shall constitute a legal day's work. The time of service of any worker employed at any time by the Contractor or by any subcontractor on any subcontract under this Contract upon the Work or upon any part of the Work contemplated by this Contract is limited and restricted to eight (8) hours during any one calendar day and 40 hours during any one calendar week, except as hereinafter provided. Notwithstanding the provisions herein above set forth, work performed by employees of Contractor in excess of eight (8) hours per day, and 40 hours during any one week, shall be permitted upon this public work upon compensation for all hours worked in excess of eight (8) hours per day at not less than one and one-half times the basic rate of pay.
- B. The Contractor and every subcontractor shall keep an accurate record showing the name of and actual hours worked each calendar day and each calendar week by each worker employed in connection with the Work or any part of the Work contemplated by this Contract. The record shall be kept open at all reasonable hours to the inspection of the District and to the Division of Labor Law Enforcement, Department of Industrial Relations of the State of California.



**GENERAL CONDITIONS**  
**SECTION F- LABOR AND CONSTRUCTION**

- C. The Contractor shall pay to the District a penalty of twenty-five dollars (\$25.00) for each worker employed in the execution of this Contract by the Contractor or by any subcontractor for each calendar day during which such worker is required or permitted to work more than eight (8) hours in any calendar day and 40 hours in any one calendar week in violation of the provisions of Article 3 (commencing at section 1810), Chapter 1, Part 7, Division 2 of the Labor Code.
- D. Any work necessary to be performed after regular working hours, or on Saturdays and Sundays or other holidays, shall be performed without additional expense to the District.
- E. District will provide inspection during normal working hours from 7:00 a.m. to 3:30 p.m. Monday through Friday. Inspection before or after this time will be charged to the Contractor as reimbursable inspection time. Inspections on weekends requires two days' notice for review and approval. Upon written request and approval the 8.5 hour working day may be changed to other limits subject to city/county ordinance.
- F. It shall be unlawful for any person to operate, permit, use, or cause to operate any of the following at the Project site, other than between the hours of 7:00 a.m. to 5:00 p.m., Monday through Friday, with no Work allowed on the District-observed holidays, unless otherwise approved by the District:
  - 1. Powered Vehicles
  - 2. Construction Equipment
  - 3. Loading and Unloading Vehicles
  - 4. Domestic Power Tools

**ARTICLE 31 PAYROLL RECORDS**

- A. Pursuant to Labor Code section 1776, Contractor and all subcontractors shall maintain weekly certified payroll records, showing the names, addresses, Social Security numbers, work classifications, straight time and overtime hours worked each day and week, and the actual per diem wages paid to each journeyman, apprentice, worker, or other employee employed by them in connection with the Work under this Contract. Contractor shall certify under penalty of perjury that records maintained and submitted by Contractor are true and accurate. Contractor shall also require subcontractor(s) to certify weekly payroll records under penalty of perjury.
- B. In accordance with Labor Code section 1771.4, the Contractor and each subcontractor shall furnish the certified payroll records directly to the Department of Industrial Relations ("DIR") on the specified interval and format prescribed by the DIR, which may include electronic submission. Contractor shall comply with all requirements and regulations from the DIR relating to labor compliance monitoring and enforcement.

**GENERAL CONDITIONS**  
**SECTION F- LABOR AND CONSTRUCTION**

- C. The payroll records described herein shall be certified and submitted by the Contractor at a time designated by the District. The Contractor shall also provide the following:
  - 1. A certified copy of the employee's payroll records shall be made available for inspection or furnished to such employee or his or her authorized representative on request.
  - 2. A certified copy of all payroll records described herein shall be made available for inspection or furnished upon request of the DIR.
- D. Unless submitted electronically, the certified payroll records shall be on forms provided by the Division of Labor Standards Enforcement ("DLSE") of the DIR or shall contain the same information as the forms provided by the DLSE.
- E. Any copy of records made available for inspection as copies and furnished upon request to the public or any public agency, the District, the Division of Apprenticeship Standards or the Division of Labor Standards Enforcement shall be marked or obliterated in such a manner as to prevent disclosure of an individual's name, address and social security number. The name and address of the Contractor awarded the Contract or performing the contract shall not be marked or obliterated.
- F. In the event of noncompliance with the requirements of this Article, the Contractor shall have ten (10) calendar days in which to comply subsequent to receipt of written notice specifying in what respects the Contractor must comply with this Article. Should noncompliance still be evident after such 10-day period, the Contractor shall pay a penalty of one hundred dollars (\$100.00) to the District for each calendar day, or portion thereof, for each worker, until strict compliance is effectuated. Upon the request of the Division of Apprenticeship Standards or the Division of Labor Standards Enforcement, such penalties shall be withheld from progress payment then due.
- G. The responsibility for compliance with this Article shall rest upon the Contractor.

**ARTICLE 32 PREVAILING RATES OF WAGES**

- A. The Contractor is aware of the requirements of Labor Code sections 1720 *et seq.* and 1770 *et seq.*, as well as California Code of Regulations, Title 8, Section 16000 *et seq.* ("Prevailing Wage Laws"), which require the payment of prevailing wage rates and the performance of other requirements on certain "public works" and "maintenance" projects. Since this Project involves an applicable "public works" or "maintenance" project, as defined by the Prevailing Wage Laws, and since the total compensation is \$1,000 or more, Contractor agrees to fully comply with such Prevailing Wage Laws. The Contractor shall obtain a copy of the prevailing rates of per diem wages at the commencement of this Contract from the website of the Division of Labor Statistics and Research of the Department of Industrial Relations located at [www.dir.ca.gov](http://www.dir.ca.gov). In the alternative, the Contractor may view a copy of the prevailing rate of per diem wages which are on file at the District's Administration Office and shall be made available to

**GENERAL CONDITIONS**  
**SECTION F- LABOR AND CONSTRUCTION**

interested parties upon request. Contractor shall make copies of the prevailing rates of per diem wages for each craft, classification, or type of worker needed to perform work on the Project available to interested parties upon request, and shall post copies at the Contractor's principal place of business and at the Project site. Contractor shall defend, indemnify and hold the District, its officials, officers, employees and authorized volunteers free and harmless from any claims, liabilities, costs, penalties or interest arising out of any failure or alleged failure to comply with the Prevailing Wage Laws.

- B. The Contractor shall forfeit as a penalty to the District not more than Two Hundred Dollars (\$200.00), pursuant to Labor Code section 1775, for each calendar day, or portion thereof, for each worker paid less than the prevailing wage rate as determined by the Director of the Department of Industrial Relations for such work or craft in which such worker is employed for any public work done under the Contract by it or by any subcontractor under it. The difference between such prevailing wage rate and the amount paid to each worker for each calendar day or portion thereof, for which each worker was paid less than the prevailing wage rate, shall be paid to each worker by the Contractor.
- C. Contractor shall post, at appropriate conspicuous points on the Project site, a schedule showing all determined general prevailing wage rates and all authorized deductions, if any, from unpaid wages actually earned.

**ARTICLE 33 PUBLIC WORKS CONTRACTOR REGISTRATION**

Pursuant to Labor Code sections 1725.5 and 1771.1, the Contractor and its subcontractors must be registered with the Department of Industrial Relations prior to the execution of a contract to perform public works. By entering into this Contract, Contractor represents that it is aware of the registration requirement and is currently registered with the DIR. Contractor shall maintain a current registration for the duration of the Project. Contractor shall further include the requirements of Labor Code sections 1725.5 and 1771.1 in any subcontract and ensure that all subcontractors are registered at the time this Contract is entered into and maintain registration for the duration of the Project.

**ARTICLE 34 EMPLOYMENT OF APPRENTICES**

- A. Contractor and all subcontractors shall comply with the requirements of Labor Code sections 1777.5 and 1777.6 in the employment of apprentices.
- B. Information relative to apprenticeship standards, wage schedules, and other requirements may be obtained from the Director of Industrial Relations, ex officio the Administrator of Apprenticeship, San Francisco, California, or from the Division of Apprenticeship Standards and its branch offices.
- C. Knowing violations of Labor Code section 1777.5 will result in forfeiture not to exceed one hundred dollars (\$100.00) for each calendar day of non-compliance pursuant to Labor Code section 1777.7.
- D. The responsibility for compliance with this Article shall rest upon the Contractor.

**GENERAL CONDITIONS**  
**SECTION F- LABOR AND CONSTRUCTION**

**ARTICLE 35 NONDISCRIMINATION/EQUAL EMPLOYMENT OPPORTUNITY**

Pursuant to Labor Code section 1735 and other applicable provisions of law, the Contractor and its subcontractors shall not discriminate against any employee or applicant for employment because of race, religious creed, color, national origin, ancestry, physical disability, mental disability, medical condition, marital status, sex, age, sexual orientation, or any other classifications protected by law on this Project. The Contractor will take affirmative action to insure that employees are treated during employment or training without regard to their race, religious creed, color, national origin, ancestry, physical disability, mental disability, medical condition, marital status, sex, age, sexual orientation, or any other classifications protected by law.

Employment Eligibility; Contractor. By executing this Contract, Contractor verifies that it fully complies with all requirements and restrictions of state and federal law respecting the employment of undocumented aliens, including, but not limited to, the Immigration Reform and Control Act of 1986, as may be amended from time to time. Such requirements and restrictions include, but are not limited to, examination and retention of documentation confirming the identity and immigration status of each employee of the Contractor. Contractor also verifies that it has not committed a violation of any such law within the five (5) years immediately preceding the date of execution of this Contract, and shall not violate any such law at any time during the term of the Contract. Contractor shall avoid any violation of any such law during the term of this Contract by participating in an electronic verification of work authorization program operated by the United States Department of Homeland Security, by participating in an equivalent federal work authorization program operated by the United States Department of Homeland Security to verify information of newly hired employees, or by some other legally acceptable method. Contractor shall maintain records of each such verification, and shall make them available to the District or its representatives for inspection and copy at any time during normal business hours. The District shall not be responsible for any costs or expenses related to Contractor's compliance with the requirements provided for or referred to herein.

Employment Eligibility; Subcontractors, Sub-subcontractors and Consultants. To the same extent and under the same conditions as Contractor, Contractor shall require all of its subcontractors, sub-subcontractors and consultants performing any part of the Work or of this Contract to make the same verifications and comply with all requirements and restrictions provided for herein.

Employment Eligibility; Failure to Comply. Each person executing this Contract on behalf of Contractor verifies that he or she is a duly authorized officer of Contractor, and understands that any of the following shall be grounds for the District to terminate the Contract for cause: (1) failure of Contractor or its subcontractors, sub-subcontractors or consultants to meet any of the requirements provided for herein; (2) any misrepresentation or material omission concerning compliance with such requirements; or (3) failure to immediately remove from the Work any person found not to be in compliance with such requirements.

**ARTICLE 36 DEBARMENT OF CONTRACTORS AND SUBCONTRACTORS**

Contractors or subcontractors may not perform work on a public works project with a subcontractor who is ineligible to perform work on a public project pursuant to Labor Code section 1777.1 or 1777.7. Any contract on a public works project entered into between a contractor and a debarred subcontractor is void as a matter of law. A debarred subcontractor

**GENERAL CONDITIONS**  
**SECTION F- LABOR AND CONSTRUCTION**

may not receive any public money for performing work as a subcontractor on a public works contract. Any public money that is paid, or may have been paid to a debarred subcontractor by a contractor on the project shall be returned to the District. The Contractor shall be responsible for the payment of wages to workers of a debarred subcontractor who has been allowed to work on the project.

**ARTICLE 37 LABOR/EMPLOYMENT SAFETY**

The Contractor shall comply with all applicable laws and regulations of the federal, state, and local government, including Cal/OSHA requirements and requirements for verification of employees' legal right to work in the United States.

The Contractor shall maintain emergency first aid treatment for his employees which complies with the Federal Occupational Safety and Health Act of 1970 (29 U.S.C. § 651 *et seq.*), and California Code of Regulations, Title 8, Industrial Relations Division 1, Department of Industrial Relations, Chapter 4. The Contractor shall ensure the availability of emergency medical services for its employees in accordance with California Code of Regulations, Title 8, Section 1512.

The Contractor shall submit the Illness and Injury Prevention Program and a Project site specific safety program to the District prior to beginning Work at the Project site. Contractor shall maintain a confined space program that meets or exceeds the District Standards. Contractor shall adhere to the District's lock out tag out program.

**ARTICLE 38 INSURANCE**

The Contractor shall obtain, and at all times during performance of the Work of Contract, maintain all of the insurance described in this Article. Contractor shall not commence Work under this Contract until it has provided evidence satisfactory to the District that it has secured all insurance required hereunder. Contractor shall not allow any subcontractor to commence work on any subcontract until it has provided evidence satisfactory to the District that the subcontractor has secured all insurance required under this Article. Failure to provide and maintain all required insurance shall be grounds for the District to terminate this Contract for cause. Contractor shall furnish District with original certificates of insurance and endorsements effective coverage required by this Contract on forms satisfactory to the District. The certificates and endorsements for each insurance policy shall be signed by a person authorized by that insurer to bind coverage on its behalf, and shall be on forms acceptable to the District. All certificates and endorsements must be received and approved by the District before Work commences.

- A. **Additional Insureds; Waiver of Subrogation.** The District, its officials, officers, employees, agents and authorized volunteers shall be named as Additional Insureds on Contractor's All Risk policy and on Contractor's and its subcontractors' policies of Commercial General Liability and Automobile Liability insurance using, for Contractor's policy/ies of Commercial General Liability insurance, ISO CG forms 20 10 and 20 37 (or endorsements providing the exact same coverage, including completed operations), and, for subcontractors' policies of Commercial General Liability insurance, ISO CG form 20 38 (or endorsements providing the exact same coverage). Notwithstanding the minimum limits set forth in this Contract for any type of insurance coverage, all

**GENERAL CONDITIONS**  
**SECTION F- LABOR AND CONSTRUCTION**

available insurance proceeds in excess of the specified minimum limits of coverage shall be available to the parties required to be named as Additional Insureds hereunder. Contractor and its insurance carriers shall provide a Waiver of Subrogation in favor of those parties.

- B. Workers' Compensation Insurance.** The Contractor shall provide workers' compensation insurance for all of the employees engaged in Work under this Contract, on or at the Site, and, in case of any sublet Work, the Contractor shall require the subcontractor similarly to provide workers' compensation insurance for all the latter's employees as prescribed by State law. Any class of employee or employees not covered by a subcontractor's insurance shall be covered by the Contractor's insurance. In case any class of employees engaged in work under this Contract, on or at the Site, is not protected under the Workers' Compensation Statutes, the Contractor shall provide or shall cause a subcontractor to provide, adequate insurance coverage for the protection of such employees not otherwise protected. The Contractor is required to secure payment of compensation to his employees in accordance with the provisions of section 3700 of the Labor Code. The Contractor shall file with the District certificates of his insurance protecting workers. Company or companies providing insurance coverage shall be acceptable to the District, if in the form and coverage as set forth in the Contract Documents.
- C. Employer's Liability Insurance.** Contractor shall provide Employer's Liability Insurance, including Occupational Disease, in the amount of at least one million dollars (\$1,000,000.00) per person per accident. Contractor shall provide District with a certificate of Employer's Liability Insurance. Such insurance shall comply with the provisions of the Contract Documents. The policy shall be endorsed, if applicable, to provide a Borrowed Servant/Alternate Employer Endorsement and contain a Waiver of Subrogation in favor of the District.
- D. Commercial General Liability Insurance.** Contractor shall provide "occurrence" form Commercial General Liability insurance coverage at least as broad as the most current ISO CGL Form 00 01, including but not limited to, premises liability, contractual liability, products/completed operations, personal and advertising injury which may arise from or out of Contractor's operations, use, and management of the Site, or the performance of its obligations hereunder. The policy shall not contain any exclusion contrary to this Contract including but not limited to endorsements or provisions limiting coverage for (1) contractual liability (including but not limited to ISO CG 24 26 or 21 39); or (2) cross-liability for claims or suits against one insured against another. Policy limits shall not be less than \$1,000,000 per occurrence for bodily injury, personal injury and property damage. If Commercial General Liability Insurance or other form with a general aggregate limit is used, either the general aggregate limit shall apply separately to this project/location or the general aggregate limit shall be twice the required occurrence limit. Defense costs shall be paid in addition to the limits.
1. Such policy shall comply with all the requirements of this Article. The limits set forth herein shall apply separately to each insured against whom claims are made or suits are brought, except with respect to the limits of liability.

**GENERAL CONDITIONS**  
**SECTION F- LABOR AND CONSTRUCTION**

Further the limits set forth herein shall not be construed to relieve the Contractor from liability in excess of such coverage, nor shall it limit Contractor's indemnification obligations to the District, and shall not preclude the District from taking such other actions available to the District under other provisions of the Contract Documents or law.

2. All general liability policies provided pursuant to the provisions of this Article shall comply with the provisions of the Contract Documents.
  3. All general liability policies shall be written to apply to all bodily injury, including death, property damage, personal injury, owned and non-owned equipment, blanket contractual liability, completed operations liability, explosion, collapse, under-ground excavation, removal of lateral support, and other covered loss, however occasioned, occurring during the policy term, and shall specifically insure the performance by Contractor of that part of the indemnification contained in these General Conditions relating to liability for injury to or death of persons and damage to property.
  4. If the coverage contains one or more aggregate limits, a minimum of 50% of any such aggregate limit must remain available at all times; if over 50% of any aggregate limit has been paid or reserved, the District may require additional coverage to be purchased by Contractor to restore the required limits. Contractor may combine primary, umbrella, and as broad as possible excess liability coverage to achieve the total limits indicated above. Any umbrella or excess liability policy shall include the additional insured endorsement described in the Contract Documents.
  5. All policies of general liability insurance shall permit and Contractor does hereby waive any right of subrogation which any insurer of Contractor may acquire from Contractor by virtue of the payment of any loss.
- E. **Automobile Liability Insurance.** Contractor shall provide "occurrence" form Automobile Liability Insurance at least as broad as ISO CA 00 01 (Any Auto) in the amount of, at least, one million dollars (\$1,000,000) per accident for bodily injury and property damage. Such insurance shall provide coverage with respect to the ownership, operation, maintenance, use, loading or unloading of any auto owned, leased, hired or borrowed by Contractor or for which Contractor is responsible, in a form and with insurance companies acceptable to the District. All policies of automobile insurance shall permit and Contractor does hereby waive any right of subrogation which any insurer of Contractor may acquire from Contractor by virtue of the payment of any loss.
1. **Builder's Risk ["All Risk"]** It is the Contractor's responsibility to maintain or cause to be maintained Builder's Risk ["All Risk"] extended coverage insurance on all work, material, equipment, appliances, tools, and structures that are or will become part of the Work and subject to loss or damage by fire, and vandalism and malicious mischief, in an amount to cover 100% of the replacement cost. The District accepts no responsibility for the Work until the Work is formally accepted by the District. The Contractor shall provide a

**GENERAL CONDITIONS**  
**SECTION F- LABOR AND CONSTRUCTION**

certificate evidencing this coverage before commencing performance of the Work.

2. The named insureds shall be Contractor, all Subcontractors of any tier (excluding those solely responsible for design work), suppliers, and District, its elected officials, officers, employees, agents and authorized volunteers, as their interests may appear. Contractor shall not be required to maintain property insurance for any portion of the Work following acceptance by District.
3. Policy shall be provided for replacement value on an "all risk" basis. There shall be no coinsurance penalty provision in any such policy. Policy must include: (1) coverage for any ensuing loss from faulty workmanship, nonconforming work, omission or deficiency in design or specifications; (2) coverage against machinery accidents and operational testing; (3) coverage for removal of debris, and insuring the buildings, structures, machinery, equipment, materials, facilities, fixtures and all other properties constituting a part of the Project; (4) transit coverage, including ocean marine coverage (unless insured by the supplier), with sub-limits sufficient to insure the full replacement value of any key equipment item; and (5) coverage with sub-limits sufficient to insure the full replacement value of any property or equipment stored either on or off the Site. Such insurance shall be on a form acceptable to District to ensure adequacy and sublimit.
4. In addition, the policy shall meet the following requirements:
  - a. Insurance policies shall be so conditioned as to cover the performance of any extra work performed under the Contract.
  - b. Coverage shall include all materials stored on site and in transit.
  - c. Coverage shall include Contractor's tools and equipment.
  - d. Insurance shall include boiler, machinery and material hoist coverage.
- F. **Contractor's Pollution Liability Coverage.** Contractor shall provide pollution liability insurance in an amount not less than \$1,000,000 per occurrence and \$2,000,000 aggregate.
- G. Contractor shall require all tiers of sub-contractors working under this Contract to provide the insurance required under this Article unless otherwise agreed to in writing by District. Contractor shall make certain that any and all subcontractors hired by Contractor are insured in accordance with this Contract. If any subcontractor's coverage does not comply with the foregoing provisions, Contractor shall indemnify and hold the District harmless from any damage, loss, cost, or expense, including attorneys' fees, incurred by the District as a result thereof.



**GENERAL CONDITIONS**  
**SECTION F- LABOR AND CONSTRUCTION**

**ARTICLE 39 FORM AND PROOF OF CARRIAGE OF INSURANCE**

- A. Any insurance carrier providing insurance coverage required by the Contract Documents shall be admitted to and authorized to do business in the State of California unless waived, in writing, by the District's Risk Manager. Carrier(s) shall have an A.M. Best rating of not less than an A:VII. Insurance deductibles or self-insured retentions must be declared by the Contractor. At the election of the District the Contractor shall either 1) reduce or eliminate such deductibles or self-insured retentions, or 2) procure a bond which guarantees payment of losses and related investigations, claims administration, and defense costs and expenses. If umbrella or excess liability coverage is used to meet any required limit(s) specified herein, the Contractor shall provide a "follow form" endorsement satisfactory to the District indicating that such coverage is subject to the same terms and conditions as the underlying liability policy.
- B. Each insurance policy required by this Contract shall be endorsed to state that: (1) coverage shall not be suspended, voided, reduced or cancelled except after thirty (30) days prior written notice by certified mail, return receipt requested, has been given to the District; and (2) any failure to comply with reporting or other provisions of the policies, including breaches of warranties, shall not affect coverage provided to the District, its officials, officers, agents, employees, and volunteers.
- C. The Certificate(s) and policies of insurance shall contain or shall be endorsed to contain the covenant of the insurance carrier(s) that it shall provide no less than thirty (30) days written notice be given to the District prior to any material modification or cancellation of such insurance. In the event of a material modification or cancellation of coverage, the District may terminate the Contract or stop the Work in accordance with the Contract Documents, unless the District receives, prior to such effective date, another properly executed original Certificate of Insurance and original copies of endorsements or certified original policies, including all endorsements and attachments thereto evidencing coverage's set forth herein and the insurance required herein is in full force and effect. Contractor shall not take possession, or use the Site, or commence operations under this Contract until the District has been furnished original Certificate(s) of Insurance and certified original copies of endorsements or policies of insurance including all endorsements and any and all other attachments as required in this Article. The original endorsements for each policy and the Certificate of Insurance shall be signed by an individual authorized by the insurance carrier to do so on its behalf.
- D. The Certificate(s) of Insurance, policies and endorsements shall so covenant and shall be construed as primary, and the District's insurance and/or deductibles and/or self-insured retentions or self-insured programs shall not be construed as contributory.
- E. District reserves the right to adjust the monetary limits of insurance coverages during the term of this Contract including any extension thereof if, in the District's reasonable judgment, the amount or type of insurance carried by the Contractor becomes inadequate.

**GENERAL CONDITIONS**  
**SECTION F- LABOR AND CONSTRUCTION**

- F. Contractor shall report to the District, in addition to the Contractor's insurer, any and all insurance claims submitted by the Contractor in connection with the Work under this Contract.

**ARTICLE 40 TIME FOR COMPLETION AND LIQUIDATED DAMAGES**

- A. **Time for Completion/Liquidated Damages.** Time is of the essence in the completion of the Work. Work shall be commenced within ten (10) Days of the date stated in the District's Notice to Proceed and shall be completed by Contractor in the time specified in the Contract Documents. The District is under no obligation to consider early completion of the Project; and the Contract completion date shall not be amended by the District's receipt or acceptance of the Contractor's proposed earlier completion date. Furthermore, Contractor shall not, under any circumstances, receive additional compensation from the District (including but not limited to indirect, general, administrative or other forms of overhead costs) for the period between the time of earlier completion proposed by the Contractor and the Contract completion date. If the Work is not completed as stated in the Contract Documents, it is understood that the District will suffer damage. In accordance with Government Code section 53069.85, being impractical and infeasible to determine the amount of actual damage, it is agreed that Contractor shall pay to the District as fixed and liquidated damages, and not as a penalty, the sum stipulated in the Contract for each calendar day of delay until the Work is fully completed. Contractor and its surety shall be liable for any liquidated damages. Any money due or to become due the Contractor may be retained to cover liquidated damages.
- B. **Inclement Weather.** Contractor shall abide by the Engineer's determination of what constitutes inclement weather. Time extensions for inclement weather shall only be granted when the Work stopped during inclement weather is on the critical path of the Project schedule.
- C. **Extension of Time.** Contractor shall not be charged liquidated damages because of any delays in completion of the Work due to unforeseeable causes beyond the control and without the fault or negligence of Contractor (or its subcontractors or suppliers). Contractor shall within five (5) Days of identifying any such delay notify the District in writing of causes of delay. The District shall ascertain the facts and extent of delay and grant extension of time for completing the Work when, in its judgment, the facts justify such an extension. Time extensions to the Project shall be requested by the Contractor as they occur and without delay. No delay claims shall be permitted unless the event or occurrence delays the completion of the Project beyond the Contract completion date.
- D. **No Damages for Reasonable Delay.** The District's liability to Contractor for delays for which the District is responsible shall be limited to only an extension of time unless such delays were unreasonable under the circumstances. In no case shall the District be liable for any costs which are borne by the Contractor in the regular course of business, including, but not limited to, home office overhead and other ongoing costs. Damages caused by unreasonable District delay, including delays caused by items that are the responsibility of the District

**GENERAL CONDITIONS**  
**SECTION F- LABOR AND CONSTRUCTION**

pursuant to Government Code section 4215, shall be based on actual costs only, no proportions or formulas shall be used to calculate any delay damages.

**ARTICLE 41 COST BREAKDOWN AND INVOICING**

Contractor shall furnish on forms Approved by the District:

- A. Within ten (10) Days of Notice to Proceed with the Contract, a detailed estimate giving a complete breakdown of the Contract price, if the Contract amount is a lump sum.
- B. A monthly itemized estimate of Work done for the purpose of making progress payments. In order for the District to consider and evaluate each progress payment application, the Contractor shall submit a detailed measurement of Work performed and a progress estimate of the value thereof before the tenth (10th) Day of the following month.
- C. Contractor shall submit, with each of its payment requests, an adjusted list of actual quantities, verified by the Engineer, for unit price items listed, if any, in the Bid Form.
- D. Following the District's Acceptance of the Work, the Contractor shall submit to the District a written statement of the final quantities of unit price items for inclusion in the final payment request.
- E. The District shall have the right to adjust any estimate of quantity and to subsequently correct any error made in any estimate for payment.

Contractor shall certify under penalty of perjury, that all cost breakdowns and periodic estimates accurately reflect the Work on the Project.

**ARTICLE 42 PROGRESS ESTIMATES AND PAYMENT**

- A. By the tenth (10th) Day of the following calendar month, Contractor shall submit to Engineer a payment request which shall set forth in detail the value of the Work done for the period beginning with the date work was first commenced and ending on the end of the calendar month for which the payment request is prepared. Contractor shall include any amount earned for authorized extra work. From the total thus computed, a deduction shall be made in the amount of five percent (5%) for retention, except where the District has adopted a finding that the Work done under the Contract is substantially complex, and then the amount withheld as retention shall be the percentage specified in the Notice Inviting Bids. From the remainder a further deduction may be made in accordance with Section B below. The amount computed, less the amount withheld for retention and any amounts withheld as set forth below, shall be the amount of the Contractor's payment request.
- B. The District may withhold a sufficient amount or amounts of any payment or payments otherwise due to Contractor, as in his judgment may be necessary to cover:

**GENERAL CONDITIONS**  
**SECTION F- LABOR AND CONSTRUCTION**

1. Payments which may be past due and payable for just claims against Contractor or any subcontractors for labor or materials furnished in and about the performance of work on the Project under this Contract.
  2. Defective work not remedied.
  3. Failure of Contractor to make proper payments to his subcontractor or for material or labor.
  4. Completion of the Contract if there is a reasonable doubt that the Work can be completed for balance then unpaid.
  5. Damage to another contractor or a third party.
  6. Amounts which may be due the District for claims against Contractor.
  7. Failure of Contractor to keep the record ("as-built") drawings up to date.
  8. Failure to provide update on construction schedule as required herein.
  9. Site cleanup.
  10. Failure to comply with Contract Documents.
  11. Liquidated damages.
  12. Legally permitted penalties.
- C. The District may apply such withheld amount or amounts to payment of such claims or obligations at its discretion with the exception of subsections (B)(1), (3), and (5) of this Article, which must be retained or applied in accordance with applicable law. In so doing, the District shall be deemed the agent of Contractor and any payment so made by the District shall be considered as a payment made under contract by the District to Contractor and the District shall not be liable to Contractor for such payments made in good faith. Such payments may be made without prior judicial determination of claim or obligations. The District will render Contractor a proper accounting of such funds disbursed on behalf of Contractor.
- D. Upon receipt, the Engineer shall review the payment request to determine whether it is undisputed and suitable for payment. If the payment request is determined to be unsuitable for payment, it shall be returned to Contractor as soon as practicable but not later than seven (7) Days after receipt, accompanied by a document setting forth in writing the reasons why the payment request is not proper. The District shall make the progress payment within 30 calendar days after the receipt of an undisputed and properly submitted payment request from Contractor, provided that a release of liens and claims has been received from the Contractor pursuant to Civil Code section 8132. The number of days available to the District to make a payment without incurring interest pursuant to

**GENERAL CONDITIONS**  
**SECTION F- LABOR AND CONSTRUCTION**

this paragraph shall be reduced by the number of days by which the Engineer exceeds the seven (7) Day requirement.

- E. A payment request shall be considered properly executed if funds are available for payment of the payment request and payment is not delayed due to an audit inquiry by the financial officer of the District.

**ARTICLE 43 SECURITIES FOR MONEY WITHHELD**

Pursuant to section 22300 of the Public Contract Code of the State of California, Contractor may request the District to make retention payments directly to an escrow agent or may substitute securities for any money withheld by the District to ensure performance under the contract. At the request and expense of Contractor, securities equivalent to the amount withheld shall be deposited with the District or with a state or federally chartered bank as the escrow agent who shall return such securities to Contractor upon satisfactory completion of the contract. Deposit of securities with an escrow agent shall be subject to a written agreement substantially in the form provided in section 22300 of the Public Contract Code.

**ARTICLE 44 CHANGES AND EXTRA WORK.**

**A. Contract Change Orders.**

1. The District, without invalidating the Contract, may order changes in the Work consisting of additions, deletions or other revisions, and the Contract Price and Contract Time shall be adjusted accordingly. Except as otherwise provided herein, all such changes in the Work shall be authorized by Change Order, and shall be performed under the applicable conditions of the Contract Documents. A Change Order signed by the Contractor indicates the Contractor's agreement therewith, including any adjustment in the Contract Price or the Contract Time, and the full and final settlement of all costs (direct, indirect and overhead) related to the Work authorized by the Change Order.
2. Contractor shall promptly execute changes in the Work as directed in writing by the District even when the parties have not reached agreement on whether the change increases the scope of Work or affects the Contract Price or Contract Time. All claims for additional compensation to the Contractor shall be presented in writing. No claim will be considered after the Work in question has been done unless a written Change Order has been issued or a timely written notice of claim has been made by Contractor.
3. Whenever any change is made as provided for herein, such change shall be considered and treated as though originally included in the Contract, and shall be subject to all terms, conditions, and provisions of the original Contract.
4. Contractor shall not be entitled to claim or bring suit for damages, whether for loss of profits or otherwise, on account of any decrease or omission of any item or portion of Work to be done.

**GENERAL CONDITIONS**  
**SECTION F- LABOR AND CONSTRUCTION**

5. No dispute, disagreement, or failure of the parties to reach agreement on the terms of the Change Order shall relieve the Contractor from the obligation to proceed with performance of the work, including Additional Work, promptly and expeditiously.
6. Contractor shall make available to the District any of the Contractor's documents related to the Project immediately upon request of the District, as set forth in Article 52.
7. Any alterations, extensions of time, Additional Work, or any other changes may be made without securing consent of the Contractor's surety or sureties.

**B. Contract Price Change.**

1. Process for Determining Adjustments in Contract Price.
  - a. Owner Initiated Change. The Contractor must submit a complete cost proposal, including any change in the Contract Price or Contract Time, within seven (7) Days after receipt of a scope of a proposed change order initiated by the District, unless the District requests that proposals be submitted in less than seven (7) Days.
  - b. Contractor Initiated Change. The Contractor must give written notice of a proposed change order required for compliance with the Contract Documents within seven (7) Days of discovery of the facts giving rise to the proposed change order.
  - c. Whenever possible, any changes to the Contract amount shall be in a lump sum mutually agreed to by the Contractor and the District.
  - d. Price quotations from the Contractor shall be accompanied by sufficiently detailed supporting documentation to permit verification by the District, including but not limited to estimates and quotations from subcontractors or material suppliers, as the District may reasonably request. Contractor shall certify the accuracy of all Change Order Requests under penalty of perjury.
  - e. If the Contractor fails to submit a complete cost proposal within the seven (7) Day period (or as requested), the District has the right to order the Contractor in writing to commence the Work immediately on a time and materials basis and/or issue a lump sum change to the Contract Price and/or Contract Time in accordance with the District's estimate. If the change is issued based on the District's estimate, the Contractor will waive its right to dispute the action unless within fifteen (15) Days following completion of the added/deleted work, the Contractor presents written proof that the District's estimate was in error.
2. Unit Price Change Orders.
  - a. When the actual quantity of a Unit Price item varies from the Bid Form, compensation for the change in quantity will be calculated by multiplying the

**GENERAL CONDITIONS**  
**SECTION F- LABOR AND CONSTRUCTION**

actual quantity by the Unit Price. This calculation may result in either an additive or deductive Final Change Order pursuant to the Contract Documents.

- b. No Mark up for Overhead and Profit. Because the Contract Unit Prices provided in the Bid Form include Overhead and Profit as determined by Contractor at the time of Bid submission, no mark up or deduction for Overhead and Profit will be included in Unit Price Change Orders.
  - c. Bid items included on the Bid Form may be deducted from the Work in their entirety without any negotiated extra costs.
  - d. Contractor acknowledges that unit quantities are estimates and agrees that the estimated unit quantities listed on the Bid Form will be adjusted to reflect the actual unit quantities which may result in an adjustment to the Contract Unit Prices. Such an adjustment will be made by execution of a final additive or deductive Change Order following Contractor's completion of the Work. Upon notification, Contractor's failure to respond within seven (7) Days will result in District's issuance of a unit quantity adjustment to the Contract Unit Prices and/or Contract Time in accordance with the Contract Documents.
  - e. The District or Contractor may make a Claim for an adjustment in the Unit Price in accordance with the Contract Documents if:
    - i. the quantity of any item of Unit Price Work performed by Contractor differs by twenty-five percent (25%) or more from the estimated quantity of such item indicated in the Contract; and
    - ii. there is no corresponding adjustment with respect to any other item of Work; and
    - iii. Contractor believes that Contractor is entitled to an increase in Unit Price as a result of having incurred additional expense or the District believes that the District is entitled to a decrease in Unit Price and the parties are unable to agree as to the amount of any such increase or decrease..
3. Lump Sum Change Orders. Compensation for Lump Sum Change Orders shall be limited to expenditures necessitated specifically by the Additional Work, and shall be segregated as follows:
- a. Labor. The costs of labor will be the actual cost for wages prevailing locally for each craft or type of worker at the time the Additional Work is done, plus employer payments of payroll taxes and insurance, health and welfare, pension, vacation, apprenticeship funds, and other direct costs resulting from Federal, State or local laws, as well as assessment or benefits required by lawful collective bargaining agreements. The use of a labor classification which would increase the Additional Work cost will not be permitted unless the Contractor establishes the necessity for such new classifications. Labor costs for equipment operators and helpers shall be reported only when such costs are not included in the invoice for equipment rental.

**GENERAL CONDITIONS**  
**SECTION F- LABOR AND CONSTRUCTION**

- b. Materials. The cost of materials reported shall be at invoice or lowest current price at which such materials are locally available in the quantities involved, plus sales tax, freight, and delivery. Materials costs shall be based upon supplier or manufacturer's invoice. If invoices or other satisfactory evidence of cost are not furnished within fifteen (15) Days of delivery, then the District shall determine the materials cost, at its sole discretion.
  - c. Tool and Equipment Use. Costs for the use of small tools, which are tools that have a replacement value of \$1,000 or less, shall be considered included in the Overhead and Profit mark-ups established below. Regardless of ownership, the rates to be used in determining equipment use costs shall not exceed listed rates prevailing locally at equipment rental agencies, or distributors, at the time the Work is performed.
4. Time and Materials Change Orders.
- a. General. The term Time and Materials means the sum of all costs reasonably and necessarily incurred and paid by Contractor for labor, materials, and equipment in the proper performance of Additional Work. Except as otherwise may be agreed to in writing by the District, such costs shall be in amounts no higher than those prevailing in the locality of the Project, and shall include only the following items.
  - b. Timely and Final Documentation.
    - i. T&M Daily Sheets. Contractor must submit timesheets, materials invoices, records of equipment hours, and records of rental equipment hours to the District's Representative for an approval signature **each day** Additional Work is performed. Failure to get the District's Representative's approval signature each Day shall result in a waiver of Contractor's right to claim these costs. The District's Representative's signature on time sheets only serves as verification that the Work was performed and is not indicative of District's agreement to Contractor's entitlement to the cost.
    - ii. T&M Daily Summary Sheets. All documentation of incurred costs ("T&M Daily Summary Sheets") shall be submitted by Contractor within **three (3) Days** of incurring the cost for labor, material, equipment, and special services as Additional Work is performed. Contractor's actual costs shall be presented in a summary table in an electronic spreadsheet file by labor, material, equipment, and special services. Each T&M Daily Summary Sheet shall include Contractor's actual costs incurred for the Additional Work performed that day and a cumulative total of Contractor's actual costs incurred for the Additional Work. Contractor's failure to provide a T&M Daily Summary Sheet showing a total cost summary within three (3) Days but within five (5) Days of performance of the Work will result in the Contractor's otherwise allowable overhead and profit being reduced by 50% for that portion of Additional Work which was not documented in a timely manner. Contractor's failure to submit the T&M Daily Summary Sheet



**GENERAL CONDITIONS**  
**SECTION F- LABOR AND CONSTRUCTION**

within five (5) Days of performance of the Work will result in a total waiver of Contractor's right to claim these costs.

- iii. T&M Total Cost Summary Sheet. Contractor shall submit a T&M Total Cost Summary Sheet, which shall include total actual costs, within **seven (7) Days** following completion of District approved Additional Work. Contractor's total actual cost shall be presented in a summary table in an electronic spreadsheet file by labor, material, equipment, and special services. Contractor's failure to submit the T&M Total Cost Summary Sheet within seven (7) Days of completion of the Additional Work will result in Contractor's waiver for any reimbursement of any costs associated with the T&M Summary Sheets or the performance of the Additional Work.
  - iv. Labor. The Contractor will be paid the cost of labor for the workers used in the actual and direct performance of the Work. The cost of labor will be the sum of the actual wages paid (which shall include any employer payments to or on behalf of the workers for health and welfare, pension, vacation, and similar purposes) substantiated by timesheets and certified payroll for wages prevailing for each craft or type of workers performing the Additional Work at the time the Additional Work is done, and the labor surcharge set forth in the Department of Transportation publication entitled *Labor Surcharge and Equipment Rental Rates*, which is in effect on the date upon which the Work is accomplished and which is a part of the Contract. The labor surcharge shall constitute full compensation for all payments imposed by Federal, State, or local laws and for all other payments made to, or on behalf of, the workers, other than actual wages.
  - v. Equipment Operator Exception. Labor costs for equipment operators and helpers shall be paid only when such costs are not included in the invoice for equipment rental.
  - vi. Foreman Exception. The labor costs for foremen shall be proportioned to all of their assigned work and only that applicable to the Additional Work shall be paid. Indirect labor costs, including, without limitation, the superintendent, project manager, and other labor identified in the Contract Documents will be considered Overhead.
- C. Materials. The cost of materials reported shall be itemized at invoice or lowest current price at which materials are locally available and delivered to the Project site in the quantities involved, plus the cost of sales tax, freight, delivery, and storage.
- 1. Trade discounts available to the purchaser shall be credited to the District notwithstanding the fact that such discounts may not have been taken by Contractor.

**GENERAL CONDITIONS**  
**SECTION F- LABOR AND CONSTRUCTION**

2. For materials secured by other than a direct purchase and direct billing to the purchaser, the cost shall be deemed to be the price paid to the actual supplier as determined by the District's Representative.
3. Payment for materials from sources owned wholly or in part by the purchaser shall not exceed the price paid by the purchaser for similar materials from said sources on Additional Work items or the current wholesale price for such materials delivered to the Project site, whichever price is lower.
4. If, in the opinion of the District's Representative, the cost of materials is excessive, or Contractor does not furnish satisfactory evidence of the cost of such materials, then the cost shall be deemed to be the lowest current wholesale price for the total quantity concerned delivered to the Project site less trade discounts.
5. The District reserves the right to furnish materials for the Additional Work and no Claim shall be allowed by Contractor for costs of such materials or Indirect Costs or profit on District furnished materials.

D. Equipment.

1. Rental Time. The rental time to be paid for equipment on the Project site shall be the time the equipment is in productive operation on the Additional Work being performed and, in addition, shall include the time required to move the equipment to the location of the Additional Work and return it to the original location or to another location requiring no more time than that required to return it to its original location; except that moving time will not be paid if the equipment is used on other than the Additional Work, even though located at the site of the Additional Work.
  - (a) Rental Time Not Allowed. Rental time will not be allowed while equipment is inoperative due to breakdowns.
  - (b) Computation Method. The following shall be used in computing the rental time of equipment on the Project site.
    - (i) When hourly rates are paid, any part of an hour less than 30 minutes of operation shall be considered to be 1/2-hour of operation, and any part of an hour in excess of 30 minutes will be considered one hour of operation.
    - (ii) When daily rates are paid, any part of a day less than 4 hours operation shall be considered to be 1/2-day of operation, and any part of an hour in excess of 4 hours will be considered one day of operation.
2. Rental Rates. Contractor will be paid for the use of equipment at the lesser of (i) the actual rental rate, or (ii) the rental rate listed for that equipment in the California Department of Transportation publication

**GENERAL CONDITIONS**  
**SECTION F- LABOR AND CONSTRUCTION**

entitled *Labor Surcharge and Equipment Rental Rates*, which is in effect on the date upon which the Contract was executed. Such rental rates will be used to compute payments for equipment whether the equipment is under Contractor's control through direct ownership, leasing, renting, or another method of acquisition. The rental rate to be applied for use of each item of equipment shall be the rate (i.e., daily, monthly) resulting in the least total cost to the District for the total period of use. If it is deemed necessary by Contractor to use equipment not listed in the publication, an equitable rental rate for the equipment will be established by the District's Representative. Contractor may furnish cost data which might assist the District's Representative in the establishment of the rental rate.

E. Contractor-Owned Equipment.

1. For Contractor-owned equipment, the allowed equipment rental rate will be limited to the monthly equipment rental rate using a utilization rate of 173 hours per month.
2. (b) For Contractor-owned equipment, the rental time to be paid for equipment on the Site shall be the time the equipment is in productive operation, unless, in the instance of standby time, the equipment could be actively used by Contractor on another project, then District shall pay for the entirety of the time the equipment is on Site. It shall be Contractor's burden to demonstrate to the District that the equipment could be actively used on another project.
  - a. All equipment shall, in the opinion of the District's Representative, be in good working condition and suitable for the purpose for which the equipment is to be used.
  - b. Before construction equipment is used on the Additional Work, Contractor shall plainly stencil or stamp an identifying number thereon at a conspicuous location, and shall furnish to the District's Representative, in duplicate, a description of the equipment and its identifying number and the scheduled Additional Work activities planned.
  - c. Unless otherwise specified, manufacturer's rating and manufacturer approved modifications shall be used to classify equipment for the determination of applicable rental rates. Equipment which has no direct power unit shall be powered by a unit of at least the minimum rating recommended by the manufacturer.

- F. Special Services. Special work or services are defined as that Additional Work characterized by extraordinary complexity, sophistication, or innovation or a combination of the foregoing attributes which are unique to the construction industry.

**GENERAL CONDITIONS**  
**SECTION F- LABOR AND CONSTRUCTION**

- G. Invoices for Special Services. When the District's Representative and Contractor determine that a special service is required which cannot be performed by the forces of Contractor or those of any of its Subcontractors, the special service may be performed by an entity especially skilled in the Additional Work. Invoices for special services based upon the current fair market value thereof may be accepted without complete itemization of labor, material, and equipment rental costs, after validation of market values by the District's Representative.
- H. Discount and Allowance. All invoices for special services will be adjusted by deducting all trade discounts offered or available, whether the discounts were taken or not. In lieu of Overhead and Profit specified herein, a total allowance not to exceed fifteen percent (15%) for Overhead and Profit will be added to invoices for Special Services.
- a. When the District determines, in its sole discretion, that competitive bidding is necessary for certain special services, Contractor shall solicit competitive bids for those special services.
- I. Excluded Costs. The term Time and Material shall not include any of the following costs or any other home or field office overhead costs, all of which are to be considered administrative costs covered by Contractor's allowance for Overhead and Profit.
1. Overhead Cost. Payroll costs and other compensation of Contractor's officers, executives, principals, general managers, engineers, architects, estimators, attorneys, auditors, accountants, purchasing and contracting agents, timekeepers, clerks, and other personnel employed by Contractor whether at the Site or in Contractor's principal office or any branch office, material yard, or shop for general administration of the Additional Work;
  2. Office Expenses. Expenses of Contractor's principal and branch offices;
  3. Capital Expenses. Any part of Contractor's capital expenses, including interest on Contractor's capital employed for the Additional Work and charges against Contractor for delinquent payments;
  4. Negligence. Costs due to the negligence of Contractor or any Subcontractor or Supplier, or anyone directly or indirectly employed by any of them or for whose acts any of them may be liable, including without limitation the correction of Defective Work, disposal of materials or equipment wrongly supplied, and making good any damage to property;
  5. Other. Other overhead or general expense costs of any kind and the cost of any item not specifically and expressly included in the Contract Documents;

**GENERAL CONDITIONS**  
**SECTION F- LABOR AND CONSTRUCTION**

6. Small Tools. Cost of small tools valued at less than \$1,000 and that remain the property of Contractor;
  7. Administrative Costs. Costs associated with the preparation of Change Orders (whether or not ultimately authorized), cost estimates, or the preparation or filing of Claims;
  8. Anticipated Lost Profits. Expenses of Contractor associated with anticipated lost profits or lost revenues, lost income or earnings, lost interest on earnings, or unpaid retention;
  9. Home Office Overhead. Costs derived from the computation of a "home office overhead" rate by application of the *Eichleay, Allegheny*, burden fluctuation, or other similar methods;
  10. Special Consultants and Attorneys. Costs of special consultants or attorneys, whether or not in the direct employ of Contractor, employed for services specifically related to the resolution of a Claim, dispute, or other matter arising out of or relating to the performance of the Additional Work.
- J. Overhead, Profit and Other Charges. The mark-up for overhead (including supervision) and profit on work added to the Contract shall be according to the following:
1. "Net Cost" is defined as consisting of costs of labor, materials, and tools and equipment only excluding overhead and profit. The costs of applicable insurance and bond premium will be reimbursed to the Contractor and subcontractors at cost only, without mark-up. Contractor shall provide District with documentation of the costs, including, but not limited to, payroll records, invoices, and such other information as District may reasonably request.
  2. For Work performed by the Contractor's forces, the added cost for overhead and profit shall not exceed fifteen percent (15%) of the Net Cost of the Work.
  3. For Work performed by a subcontractor, the added cost for overhead and profit shall not exceed fifteen percent (15%) of the subcontractor's Net Cost of the Work to which the Contractor may add five percent (5%) of the subcontractor's Net Cost.
  4. For Work performed by a sub-subcontractor, the added cost for overhead and profit shall not exceed fifteen percent (15%) of the sub-subcontractor's Net Cost for Work to which the subcontractor and general contractor may each add an additional five percent (5%) of the Net Cost of the lower tier subcontractor.
  5. No additional mark-up will be allowed for lower tier subcontractors, and in no case shall the added cost for overhead and profit payable

**GENERAL CONDITIONS**  
**SECTION F- LABOR AND CONSTRUCTION**

by District exceed twenty-five percent (25%) of the Net Cost as defined herein, of the party that performs the Work.

6. All of the following costs are included in the markups for overhead and profit described above, and Contractor shall not receive any additional compensation for: Submittals, drawings, field drawings, Shop Drawings, including submissions of drawings; field inspection; General Superintendence; General administration and preparation of cost proposals, schedule analysis, Change Orders, and other supporting documentation; computer services; reproduction services; Salaries of project engineer, superintendent, timekeeper, storekeeper, and secretaries; Janitorial services; Small tools, incidentals and consumables; Temporary On-Site facilities (Offices, Telephones, High Speed Internet Access, Plumbing, Electrical Power, Lighting; Platforms, Fencing, Water), Jobsite and Home office overhead or other expenses; vehicles and fuel used for work otherwise included in the Contract Documents; Surveying; Estimating; Protection of Work; Handling and disposal fees; Final Cleanup; Other Incidental Work; Related Warranties; insurance and bond premiums.
7. For added or deducted Work by subcontractors, the Contractor shall furnish to the District the subcontractor's signed detailed record of the cost of labor, material and equipment, including the subcontractor markup for overhead and profit. The same requirement shall apply to sub-subcontractors
8. For added or deducted work furnished by a vendor or supplier, the Contractor shall furnish to the District a detailed record of the cost to the Contractor, signed by such vendor or supplier.
9. Any change in the Work involving both additions and deletions shall indicate a net total cost, including subcontracts and materials. Allowance for overhead and profit, as specified herein, shall be applied if the net total cost is an increase in the Contract Price; overhead and profit allowances shall not be applied if the net total cost is a deduction to the Contract Price. The estimated cost of deductions shall be based on labor and material prices on the date the Contract was executed.
10. Contractor shall not reserve a right to assert impact costs, extended job site costs, extended overhead, constructive acceleration and/or actual acceleration beyond what is stated in the Change Order for Work. No claims shall be allowed for impact, extended overhead costs, constructive acceleration and/or actual acceleration due to a multiplicity of changes and/or clarifications. The Contractor may not change or modify the District's change order form in an attempt to reserve additional rights.
11. If the District disagrees with the proposal submitted by Contractor, it will notify the Contractor and the District will provide its opinion of the

**GENERAL CONDITIONS**  
**SECTION F- LABOR AND CONSTRUCTION**

appropriate price and/or time extension. If the Contractor agrees with the District, a Change Order will be issued by the District. If no agreement can be reached, the District shall have the right to issue a unilateral Change Order setting forth its determination of the reasonable additions or savings in costs and time attributable to the extra or deleted work. Such determination shall become final and binding if the Contractor fails to submit a claim in writing to the District within fifteen (15) Days of the issuance of the unilateral Change Order, disputing the terms of the unilateral Change Order, and providing such supporting documentation for its position as the District may require.

**K. Change of Contract Times.**

1. The Contract Times may only be changed by a Change Order.
2. All changes in the Contract Price and/or adjustments to the Contract Times related to each change shall be included in Contractor's COR pursuant to this Article. No cost or time will be allowed for cumulative effects of multiple changes. All Change Orders must state that the Contract Time is not changed or is either increased or decreased by a specific number of days. Failure to include a change to time shall waive any change to the time unless the parties mutually agree in writing to postpone a determination of the change to time resulting from the Change Order.
3. Notice of the amount of the request for adjustment in the Contract Times with supporting data shall be delivered within seven (7) Days after such start of occurrence, unless District's Representative allows an additional period of time to ascertain more accurate data in support of the request. No extension of time or additional compensation shall be given for a delay if the Contractor failed to give notice in the manner and within the time prescribed.
4. District may elect, at District's sole discretion, to grant an extension in Contract Times, without Contractor's request, because of delays or other factors.

**L. Use of Float and Critical Path.**

1. Float is for the benefit of the Project. Float shall not be considered for the exclusive use or benefit of either the District or the Contractor.
2. Contractor shall not be entitled to compensation, and District will not compensate Contractor, for delays which impact early completion. Any difference in time between the Contractor's early completion and the Contract Time shall be considered a part of the Project float.
3. Contractor's entitlement to an extension of the Contract Times is limited to a District-caused extension of the critical path, reduced by the Contractor's concurrent delays, and established by a proper time impact analysis. No time extension shall be allowed unless, and then only to the extent that, the District-caused delay extends the critical path beyond the

**GENERAL CONDITIONS**  
**SECTION F- LABOR AND CONSTRUCTION**

previously approved Contract Time. If approved, the increase in time required to complete the Work shall be added to the Contract Time.

4. Contractor shall not be entitled to an adjustment in the Contract Price or Contract Times for delays within the control of Contractor. Delays attributable to and within the control of a Subcontractor or Supplier shall be deemed to be delays within the control of Contractor.
5. If Contractor is delayed in the performance or progress of the Work by fire, flood, epidemic, abnormal weather conditions (as determined by the District), Acts of God, acts or failures to act of utility owners not under the control of District, or other causes not the fault of and beyond control of District and Contractor, then Contractor shall be entitled to a time extension when the Work stopped is on the critical path. Such a non-compensable adjustment shall be Contractor's sole and exclusive remedy for such delays. Contractor must submit a timely request in accordance with the requirements of this Article.

M. Utility-Related Delays.

1. Contractor shall immediately notify in writing the utility owner and District's Representative of its construction schedule and any subsequent changes in the construction schedule which will affect the time available for protection, removal, or relocation of utilities. Requests for extensions of time arising out of utility relocation or repair delays shall be filed in accordance with this Article.
2. Contractor shall not be entitled to damages or additional payment for delays attributable to utility relocations or alterations if correctly located, as noted in the Contract Documents or by the Underground Service Alert survey.

N. Content for Requests for Contract Extension. Contractor's justification for entitlement shall be clear and complete citing specific Contract Document references and reasons on which Contractor's entitlement is based. At a minimum, each request for a time extension must include:

1. Each request for an extension of Contract Time must identify the impacting event, in narrative form, providing a description of the delay event and sufficient justification as to why the Contractor is entitled to a time extension. Contractor must demonstrate that the delay arises from unforeseeable causes beyond the control and without the fault or negligence of both Contractor and any Subcontractors or Suppliers, or any other persons or organizations employed by any of them or for whose acts any of them may be liable, and that such causes in fact lead to performance or completion of the Work, or specified part in question, beyond the corresponding Contract Times, despite Contractor's reasonable and diligent actions to guard against those effects.



**GENERAL CONDITIONS**  
**SECTION F- LABOR AND CONSTRUCTION**

2. Each request for an extension of Contract Time must include a time impact analysis in CPM format, using the Contemporaneous Impacted As-Planned Schedule Analysis to calculate the impact of the delay event.

O. No Damages for Reasonable Delay.

1. District's liability to Contractor for delays for which District is responsible shall be limited to only an extension of time unless such delays were unreasonable under the circumstances. In no case shall District be liable for any costs which are borne by the Contractor in the regular course of business, including, but not limited to, home office overhead and other ongoing costs.
2. Damages caused by unreasonable District delay that impact the critical path, including delays caused by items that are the responsibility of the District pursuant to Government Code section 4215, shall be compensated at the Daily Rate established in the Special Conditions. No other calculations, proportions or formulas shall be used to calculate any delay damages.
3. District and District's Representative, and the officers, members, partners, employees, agents, consultants, or subcontractors of each of them, shall not be liable to Contractor for any claims, costs, losses, or damages (including but not limited to all fees and charges of engineers, architects, attorneys, and other professionals and all court or arbitration or other dispute resolution costs) sustained by Contractor on or in connection with any other project or anticipated project.
4. Contractor's failure, neglect, or refusal to comply with the requirements of the Contract Documents, or any portion thereof, shall bar Contractor's request for extensions of the Contract Times. Such failure, neglect, or refusal prejudices District's and District's Representative's ability to recognize and mitigate delay, and such failure, neglect, or refusal prevent the timely analysis of requests for extensions of Contract Times, and whether such extensions may be warranted. Contractor hereby waives all rights to extensions of Contract Times due to delays or accelerations that result from or occur during periods of time for which Contractor fails, neglects, or refuses to fully comply with the requirements of this Article.

**ARTICLE 45 FINAL ACCEPTANCE AND PAYMENT**

- A. The acceptance of the Work on behalf of the District will be made by the Engineer. Such acceptance by the District shall not constitute a waiver of defects. When the Work has been accepted there shall be paid to Contractor a sum equal to the contract price less any amounts previously paid Contractor and less any amounts withheld by the District from Contractor under the terms of the contract. The final five percent (5%), or the percentage specified in the notice inviting bids where the District has adopted a finding of substantially complete, shall not become due and payable until five (5) calendar days shall have elapsed after the expiration of the period within which all claims may be filed

**GENERAL CONDITIONS**  
**SECTION F- LABOR AND CONSTRUCTION**

under the provisions of Civil Code section 9356. If the Contractor has placed securities with the District as described herein, the Contractor shall be paid a sum equal to one hundred percent (100%) of the contract price less any amounts due the District under the terms of the Contract.

- B. Unless Contractor advises the District in writing prior to acceptance of the final five percent (5%) or the percentage specified in the notice inviting bids where the District has adopted a finding of substantially complete, or the return of securities held as described herein, said acceptance shall operate as a release to the District of all claims and all liability to Contractor for all things done or furnished in connection with this work and for every act of negligence of the District and for all other claims relating to or arising out of this work. If Contractor advises the District in writing prior to acceptance of final payment or return of the securities that there is a dispute regarding the amount due the Contractor, the District may pay the undisputed amount contingent upon the Contractor furnishing a release of all undisputed claims against the District with the disputed claims in stated amounts being specifically excluded by Contractor from the operation of the release. No payments, however, final or otherwise, shall operate to release Contractor or its sureties from the Faithful Performance Bond, Labor and Material Payment Bond, or from any other obligation under this contract.
- C. In case of suspension of the contract any unpaid balance shall be and become the sole and absolute property of the District to the extent necessary to repay the District any excess in the cost of the Work above the contract price.
- D. Final payment shall be made no later than 60 days after the date of acceptance of the Work by the District or the date of occupation, beneficial use and enjoyment of the Work by the District including any operation only for testing, start-up or commissioning accompanied by cessation of labor on the Work, provided that a release of liens and claims has been received from the Contractor pursuant to Civil Code section 8136. In the event of a dispute between the District and the Contractor, the District may withhold from the final payment an amount not to exceed 150% of the disputed amount.
- E. Within ten (10) calendar days from the time that all or any portion of the retention proceeds are received by Contractor, Contractor shall pay each of its subcontractors from whom retention has been withheld each subcontractor's share of the retention received. However, if a retention payment received by Contractor is specifically designated for a particular subcontractor, payment of the retention shall be made to the designated subcontractor if the payment is consistent with the terms of the subcontract.

**ARTICLE 46 OCCUPANCY**

The District reserves the right to occupy or utilize any portion of the Work at any time before completion, and such occupancy or use shall not constitute acceptance of any part of Work covered by this Contract. This use shall not relieve the Contractor of its responsibilities under the Contract.

**GENERAL CONDITIONS**  
**SECTION F- LABOR AND CONSTRUCTION**

**ARTICLE 47 INDEMNIFICATION**

To the fullest extent permitted by law, Contractor shall immediately defend (with counsel of the District's choosing), indemnify and hold harmless the District, officials, officers, agents, employees, and representatives, and each of them from and against:

- A. Any and all claims, demands, causes of action, costs, expenses, injuries, losses or liabilities, in law or in equity, of every kind or nature whatsoever, but not limited to, injury to or death, including wrongful death, of any person, and damages to or destruction of property of any person, arising out of, related to, or in any manner directly or indirectly connected with the Work or this Contract, including claims made by subcontractors for nonpayment, including without limitation the payment of all consequential damages and attorney's fees and other related costs and expenses, however caused, regardless of whether the allegations are false, fraudulent, or groundless, and regardless of any negligence of the District or its officers, employees, or authorized volunteers (including passive negligence), except the sole negligence or willful misconduct or active negligence of the District or its officials, officers, employees, or authorized volunteers.
- B. Contractor's defense and indemnity obligation herein includes, but is not limited to damages, fines, penalties, attorney's fees and costs arising from claims under the Americans with Disabilities Act (ADA) or other federal or state disability access or discrimination laws arising from Contractor's Work during the course of construction of the improvements or after the Work is complete, as the result of defects or negligence in Contractor's construction of the improvements.
- C. Any and all actions, proceedings, damages, costs, expenses, fines, penalties or liabilities, in law or equity, of every kind or nature whatsoever, arising out of, resulting from, or on account of the violation of any governmental law or regulation, compliance with which is the responsibility of Contractor;
- D. Any and all losses, expenses, damages (including damages to the Work itself), attorney's fees, and other costs, including all costs of defense which any of them may incur with respect to the failure, neglect, or refusal of Contractor to faithfully perform the Work and all of Contractor's obligations under the agreement. Such costs, expenses, and damages shall include all costs, including attorney's fees, incurred by the indemnified parties in any lawsuit to which they are a party.

Contractor shall immediately defend, at Contractor's own cost, expense and risk, with the District Board's choosing, any and all such aforesaid suits, actions or other legal proceedings of every kind that may be brought or instituted against the District, its officials, officers, agents, employees and representatives. Contractor shall pay and satisfy any judgment, award or decree that may be rendered against the District, its officials, officers, employees, agents, employees and representatives, in any such suit, action or other legal proceeding. Contractor shall reimburse the District, its officials, officers, agents, employees and representatives for any and all legal expenses and costs incurred by each of them in connection therewith or in enforcing the indemnity herein provided. The only limitations on this provision shall be those imposed by Civil Code section 2782.

**GENERAL CONDITIONS**  
**SECTION F- LABOR AND CONSTRUCTION**

**ARTICLE 48 PROCEDURE FOR RESOLVING DISPUTES**

In accordance with Public Contract Code sections 20104 *et seq.* and other applicable law, public works claims of \$375,000 or less which arise between the Contractor and the District shall be resolved under the following statutory procedure unless the District has elected to resolve the dispute pursuant to Public Contract Code section 10240 *et seq.*

- A. **All Claims.** All claims shall be submitted in writing and accompanied by substantiating documentation. Claims must be filed on or before the date of final payment unless other notice requirements are provided in the contract. "Claim" means a separate demand by the Contractor for (1) a time extension, (2) payment of money or damages arising from work done by or on behalf of the Contractor and payment of which is not otherwise expressly provided for or the Contractor is not otherwise entitled, or (3) an amount the payment of which is disputed by the District.
  
- B. **Claims Under \$50,000.** The District shall respond in writing to the claim within 45 calendar days of receipt of the claim, or, the District may request, in writing, within 30 calendar days of receipt of the claim, any additional documentation supporting the claim or relating to defenses or claims the District may have. If additional information is needed thereafter, it shall be provided upon mutual agreement of the District and the Contractor. The District's written response shall be submitted 15 calendar days after receiving the additional documentation, or within the same period of time taken by the Contractor to produce the additional information, whichever is greater.
  
- C. **Claims over \$50,000 but less than or equal to \$375,000.** The District shall respond in writing within 60 calendar days of receipt, or, may request in writing within 30 calendar days of receipt of the claim, any additional documents supporting the claim or relating to defenses or claims the District may have against the District. If additional information is needed thereafter, it shall be provided pursuant to mutual agreement between the District and the Contractor. The District response shall be submitted within 30 calendar days after receipt of the further documents, or within the same period of time taken by the Contractor to produce the additional information or documents, whichever is greater. The Contractor shall make these records and documents available at all reasonable times, without any direct charge.
  
- D. **All Claims.** The Contractor will submit the claim justification in the following format:
  - 1. Summary of claim merit and price, and Contract clause pursuant to which the claim is made.
  - 2. List of documents relating to claim:
    - a. Specifications
    - b. Drawings
    - c. Clarifications (Requests for Information)
    - d. Schedules

**GENERAL CONDITIONS**  
**SECTION F- LABOR AND CONSTRUCTION**

e. Other (All Related Documents)

3. Chronology of events and correspondence.
4. Analysis of claim merit.
5. Analysis of claim cost.
6. Analysis of time impact analysis in CPM format.
7. Cover letter and certification of validity of the claim.

E. **All Claims.** If the Contractor disputes the District's response, or if the District fails to respond within the statutory time period(s), the Contractor may so notify the District within 15 calendar days of the receipt of the response or the failure to respond, and demand an informal conference to meet and confer for settlement. Upon such demand, the District shall schedule a meet and confer conference within 30 calendar days.

F. The Contractor must comply with the claims filing procedures set forth in Government Code sections 900 *et seq.* for any claim or any portion thereof that remains in dispute, after the meet and confer conference. For purposes of those provisions, the time within which a claim must be filed shall be tolled from the time the Contractor submits the written claim until the time the claim is denied, including any time utilized for the meet and confer conference. Submission of a claim, properly certified, with all required supporting documentation, and written rejection or denial of all or part of the claim by the District, is a condition precedent to any action, proceeding, litigation, suit, general conditions claim, or demand for arbitration by Contractor.

G. **Government Code Claim.** In addition to any and all contract requirements pertaining to notices of and requests for compensation or payment for extra work, disputed work, construction claims and/or changed conditions, the Contractor must comply with the claim procedures set forth in Government Code sections 900 *et seq.* prior to filing any lawsuit against the District. Such Government Code claims and any subsequent lawsuit based upon the Government Code claims shall be limited to those matters that remain unresolved after all procedures pertaining to extra work, disputed work, construction claims, and/or changed conditions have been followed by Contractor. If no such Government Code claim is submitted, or if the prerequisite contractual requirements are not otherwise satisfied as specified herein, Contractor shall be barred from bringing and maintaining a valid lawsuit against the District.

**ARTICLE 49 DISTRICT'S RIGHT TO TERMINATE CONTRACT**

**A. Termination for Cause by the District:**

1. In the sole estimation of the District, if the Contractor refuses or fails to prosecute the Work or any separable part thereof with such diligence as will

**GENERAL CONDITIONS**  
**SECTION F- LABOR AND CONSTRUCTION**

insure its completion within the time specified by the Contract Documents, or any extension thereof, or fails to complete such Work within such time, or if the Contractor should be adjudged a bankrupt, or if it should make a general assignment for the benefit of its creditors, or if a receiver should be appointed on account of its insolvency, or the Contractor or any of its subcontractors should violate any of the provisions of this Contract, the District may serve written notice upon the Contractor and its Surety of the District's intention to terminate this Contract. This notice of intent to terminate shall contain the reasons for such intention to terminate this Contract, and a statement to the effect that the Contractor's right to perform this Contract shall cease and terminate upon the expiration of ten (10) calendar days unless such violations have ceased and arrangements satisfactory to the District have been made for correction of said violations.

2. In the event that the District serves such written notice of termination upon the Contractor and the Surety, the Surety shall have the right to take over and perform the Contract. If the Surety does not: (1) give the District written notice of Surety's intention to take over and commence performance of the Contract within 15 calendar days of the District's service of said notice of intent to terminate upon Surety; and (2) actually commence performance of the Contract within 30 calendar days of the District's service of said notice upon Surety; then the District may take over the Work and prosecute the same to completion by separate contract or by any other method it may deem advisable for the account and at the expense of the Contractor.
3. In the event that the District elects to obtain an alternative performance of the Contract as specified above: (1) the District may, without liability for so doing, take possession of and utilize in completion of the Work such materials, appliances, plants and other property belonging to the Contractor that are on the site and reasonably necessary for such completion (A special lien to secure the claims of the District in the event of such suspension is hereby created against any property of Contractor taken into the possession of the District under the terms hereof and such lien may be enforced by sale of such property under the direction of the District Board without notice to Contractor. The proceeds of the sale after deducting all expenses thereof and connected therewith shall be credited to Contractor. If the net credits shall be in excess of the claims of the District against Contractor, the balance will be paid to Contractor or Contractor's legal representatives.); and (2) Surety shall be liable to the District for any cost or other damage to the District necessitated by the District securing an alternate performance pursuant to this Article.

**B. Termination for Convenience by the District:**

1. The District may terminate performance of the Work called for by the Contract Documents in whole or, from time to time, in part, if the District determines that a termination is in the District's interest.
2. The Contractor shall terminate all or any part of the Work upon delivery to the Contractor of a Notice of Termination specifying that the termination is for the

**GENERAL CONDITIONS**  
**SECTION F- LABOR AND CONSTRUCTION**

convenience of the District, the extent of termination, and the Effective Date of such termination.

3. After receipt of Notice of Termination, and except as directed by the District's Representative, the Contractor shall, regardless of any delay in determining or adjusting any amounts due under this Termination for Convenience clause, immediately proceed with the following obligations:
  - a. Stop Work as specified in the Notice.
  - b. Complete any Work specified in the Notice of Termination in a least cost/shortest time manner while still maintaining the quality called for under the Contract Documents.
  - c. Leave the property upon which the Contractor was working and upon which the facility (or facilities) forming the basis of the Contract Document is situated in a safe and sanitary manner such that it does not pose any threat to the public health or safety.
  - d. Terminate all subcontracts to the extent that they relate to the portions of the Work terminated.
  - e. Place no further subcontracts or orders, except as necessary to complete the continued portion of the Contract.
  - f. Submit to the District's Representative, within ten (10) calendar days from the Effective Date of the Notice of Termination, all of the usual documentation called for by the Contract Documents to substantiate all costs incurred by the Contractor for labor, materials and equipment through the Effective Date of the Notice of Termination. Any documentation substantiating costs incurred by the Contractor solely as a result of the District's exercise of its right to terminate this Contract pursuant to this clause, which costs the contractor is authorized under the Contract documents to incur, shall: (1) be submitted to and received by the Engineer no later than 30 calendar days after the Effective Date of the Notice of Termination; (2) describe the costs incurred with particularity; and (3) be conspicuously identified as "Termination Costs occasioned by the District's Termination for Convenience."
4. Termination of the Contract shall not relieve Surety of its obligation for any just claims arising out of or relating to the Work performed.
5. In the event that the District exercises its right to terminate this Contract pursuant to this clause, the District shall pay the Contractor, upon the Contractor's submission of the documentation required by this clause and other applicable provisions of the Contract Documents, the following amounts:
  - a. All actual reimbursable costs incurred according to the provisions of this Contract.

**GENERAL CONDITIONS**  
**SECTION F- LABOR AND CONSTRUCTION**

- b. A reasonable allowance for profit on the cost of the Work performed, provided Contractor establishes to the satisfaction of the District's Representative that it is reasonably probable that Contractor would have made a profit had the Contract been completed and provided further, that the profit allowed shall in no event exceed fifteen (15%) percent of the costs.
  - c. A reasonable allowance for Contractor's administrative costs in determining the amount payable due to termination of the Contract under this Article.
6. Notwithstanding any other provision of this Article, when immediate action is necessary to protect life and safety or to reduce significant exposure or liability, the District may immediately order Contractor to cease Work on the Project until such safety or liability issues are addressed to the satisfaction of the District or the Contract is terminated.

**ARTICLE 50 WARRANTY AND GUARANTEE OF WORK**

- A. Contractor hereby warrants that materials and Work shall be completed in conformance with the Contract Documents and that the materials and Work provided will fulfill the requirements of this Warranty. Contractor hereby agrees to repair or replace, at the discretion of the District, any or all Work that may prove to be defective in its workmanship, materials furnished, methods of installation or fail to conform to the Contract Document requirements together with any other Work which may be damaged or displaced by such defect(s) within a period of one (1) year from the date of the Notice of Completion of the Project without any expense whatever to the District, ordinary wear and tear and unusual abuse and neglect excepted. Contractor shall be required to promptly repair or replace defective equipment or materials, at Contractor's option. All costs associated with such corrective actions and testing, including the removal, replacement, and reinstatement of equipment and materials necessary to gain access, shall be the sole responsibility of the Contractor.
- B. For any Work so corrected, Contractor's obligation hereunder to correct defective Work shall be reinstated for an additional one (1) year period, commencing with the date of acceptance of such corrected Work. The reinstatement of the one (1) year warranty shall apply only to that portion of work that was corrected. Contractor shall perform such tests as District may require to verify that any corrective actions, including, without limitation, redesign, repairs, and replacements comply with the requirements of the Contract. In the event of Contractor's failure to comply with the above-mentioned conditions within ten (10) calendar days after being notified in writing of required repairs, to the reasonable satisfaction of the District, the District shall have the right to correct and replace any defective or non-conforming Work and any work damaged by such work or the replacement or correction thereof at Contractor's sole expense. Contractor shall be obligated to fully reimburse the District for any expenses incurred hereunder immediately upon demand.



**GENERAL CONDITIONS**  
**SECTION F- LABOR AND CONSTRUCTION**

- C. In addition to the warranty set forth in this Article, Contractor shall obtain for District all warranties that would be given in normal commercial practice and assign to District any and all manufacturer's or installer's warranties for equipment or materials not manufactured by Contractor and provided as part of the Work, to the extent that such third-party warranties are assignable and extend beyond the warranty period set forth in this Article. Contractor shall furnish the District with all warranty and guarantee documents prior to final Acceptance of the Project by the District as required.
- D. When specifically indicated in the Contract Documents or when directed by the Engineer, the District may furnish materials or products to the Contractor for installation. In the event any act or failure to act by Contractor shall cause a warranty applicable to any materials or products purchased by the District for installation by the Contractor to be voided or reduced, Contractor shall indemnify District from and against any cost, expense, or other liability arising therefrom, and shall be responsible to the District for the cost of any repairs, replacement or other costs that would have been covered by the warranty but for such act or failure to act by Contractor.
- E. The Contractor shall remedy at its expense any damage to District-owned or controlled real or personal property.
- F. The District shall notify the Contractor, in writing, within a reasonable time after the discovery of any failure, defect, or damage. The Contractor shall within ten (10) calendar days after being notified commence and perform with due diligence all necessary Work. If the Contractor fails to promptly remedy any defect, or damage; the District shall have the right to replace, repair or otherwise remedy the defect, or damage at the Contractor's expense.
- G. In the event of any emergency constituting an immediate hazard to health, safety, property, or licensees, when caused by Work of the Contractor not in accordance with the Contract requirements, the District may undertake at Contractor's expense, and without prior notice, all Work necessary to correct such condition.
- H. Acceptance of Defective Work.
  - 1. If, instead of requiring correction or removal and replacement of Defective Work, the District prefers to accept it, District may do so. Contractor shall pay all claims, costs, losses, and damages (including but not limited to all fees and charges of engineers, architects, attorneys, and other professionals and all court or arbitration or other dispute resolution costs) attributable to District's evaluation of and determination to accept such Defective Work and for the diminished value of the Work.
  - 2. If any acceptance of defective work occurs prior to release of the Project Retention, a Change Order will be issued incorporating the necessary revisions in the Contract Documents with respect to the Work, and District shall be entitled to an appropriate decrease in the Contract Price, reflecting the diminished value of Work and all costs incurred by District.

**GENERAL CONDITIONS**  
**SECTION F- LABOR AND CONSTRUCTION**

3. If the Project Retention is held in an escrow account as permitted by the Contract Documents, Contractor will promptly alert the escrow holder, in writing, of the amount of Retention to be paid to District.
  4. If the acceptance of Defective Work occurs after release of the Project Retention, an appropriate amount will be paid by Contractor to District.
- I. District May Correct Defective Work.
1. If Contractor fails within a reasonable time after written notice from District's Representative to correct Defective Work, or to remove and replace rejected Work as required by District, or if Contractor fails to perform the Work in accordance with the Contract Documents, or if Contractor fails to comply with any other provision of the Contract Documents, District may, after seven (7) Days' written notice to Contractor, correct, or remedy any such deficiency.
  2. In connection with such corrective or remedial action, District may exclude Contractor from all or part of the Site, take possession of all or part of the Work and suspend Contractor's services related thereto, take possession of Contractor's tools, appliances, construction equipment and machinery at the Site, and incorporate in the Work all materials and equipment stored at the Site or for which District has paid Contractor but which are stored elsewhere. Contractor shall allow District and District's Representative, and the agents, employees, other contractors, and consultants of each of them, access to the Site to enable District to exercise the rights and remedies to correct the Defective Work.
  3. All claims, costs, losses, and damages (including but not limited to all fees and charges of engineers, architects, attorneys, and other professionals and all court or arbitration or other dispute resolution costs) incurred or sustained by District correcting the Defective Work will be charged against Contractor, and a Change Order will be issued incorporating the necessary revisions into the Contract Documents with respect to the Work; and District shall be entitled to an appropriate decrease in the Contract Price.
  4. Such claims, costs, losses and damages will include, but not be limited to, all costs of repair, or replacement of work of others destroyed or damaged by correction, removal, or replacement of Defective Work.
  5. If the Change Order is executed after all payments under the Contract have been paid by District and the Project Retention is held in an escrow account as permitted by the Contract Documents, Contractor will promptly alert the escrow holder, in writing, of the amount of Retention to be paid to District.
  6. If the Change Order is executed after release of the Project Retention, an appropriate amount will be paid by Contractor to District.
  7. Contractor shall not be allowed an extension of the Contract Times because of any delay in the performance of the Work attributable to District correcting Defective work.

**GENERAL CONDITIONS**  
**SECTION F- LABOR AND CONSTRUCTION**

- J. Nothing in the Warranty or in the Contract Documents shall be construed to limit the rights and remedies available to District at law or in equity, including, but not limited to, Code of Civil Procedure section 337.15.

**ARTICLE 51 DOCUMENT RETENTION & EXAMINATION**

- A. In accordance with Government Code section 8546.7, records of both the District and the Contractor shall be subject to examination and audit by the State Auditor General for a period of three (3) years after final payment.
- B. Contractor shall make available to the District any of the Contractor's other documents related to the Project immediately upon request of the District.
- C. In addition to the State Auditor rights above, the District shall have the right to examine and audit all books, estimates, records, contracts, documents, bid documents, subcontracts, and other data of the Contractor (including computations and projections) related to negotiating, pricing, or performing the modification in order to evaluate the accuracy and completeness of the cost or pricing data at no additional cost to the District, for a period of four (4) years after final payment.

**ARTICLE 52 SEPARATE CONTRACTS**

- A. The District reserves the right to let other contracts in connection with this Work or on the Project site. Contractor shall permit other contractors reasonable access and storage of their materials and execution of their work and shall properly connect and coordinate its Work with theirs.
- B. To ensure proper execution of its subsequent Work, Contractor shall immediately inspect work already in place and shall at once report to the Engineer any problems with the Work in place or discrepancies with the Contract Documents.
- C. Contractor shall ascertain to its own satisfaction the scope of the Project and nature of any other contracts that have been or may be awarded by the District in prosecution of the Project to the end that Contractor may perform this Contract in the light of such other contracts, if any. Nothing herein contained shall be interpreted as granting to Contractor exclusive occupancy at site of the Project. Contractor shall not cause any unnecessary hindrance or delay to any other contractor working on the Project. If simultaneous execution of any contract for the Project is likely to cause interference with performance of some other contract or contracts, the Engineer shall decide which Contractor shall cease Work temporarily and which contractor shall continue or whether work can be coordinated so that contractors may proceed simultaneously. The District shall not be responsible for any damages suffered or for extra costs incurred by Contractor resulting directly or indirectly from award, performance, or attempted performance of any other contract or contracts on the Project site.

**GENERAL CONDITIONS**  
**SECTION F- LABOR AND CONSTRUCTION**

**ARTICLE 53 NOTICE AND SERVICE THEREOF**

All notices shall be in writing and either served by personal delivery or mailed to the other party as designated in the Bid Forms. Written notice to the Contractor shall be addressed to Contractor's principal place of business unless Contractor designates another address in writing for service of notice. Notice to District shall be addressed to the District as designated in the Notice Inviting Bids unless District designates another address in writing for service of notice. Notice shall be effective upon receipt or five (5) calendar days after being sent by first class mail, whichever is earlier. Notice given by facsimile shall not be effective unless acknowledged in writing by the receiving party.

**ARTICLE 54 NOTICE OF THIRD PARTY CLAIMS**

Pursuant to Public Contract Code section 9201, the District shall provide the Contractor with timely notification of the receipt of any third-party claims relating to the Contract. The District is entitled to recover reasonable costs incurred in providing such notification.

**ARTICLE 55 STATE LICENSE BOARD NOTICE**

Contractors are required by law to be licensed and regulated by the Contractors' State License Board which has jurisdiction to investigate complaints against contractors if a complaint regarding a patent act or omission is filed within four (4) years of the date of the alleged violation. A complaint regarding a latent act or omission pertaining to structural defects must be filed within ten (10) years of the date of the alleged violation. Any questions concerning a contractor may be referred to the Registrar, Contractors' State License Board, P.O. Box 26000, Sacramento, California 95826.

**ARTICLE 56 INTEGRATION**

- A. **Oral Modifications Ineffective.** No oral order, objection, direction, claim or notice by any party or person shall affect or modify any of the terms or obligations contained in the Contract Documents.
- B. **Contract Documents Represent Entire Contract.** The Contract Documents represent the entire agreement of the District and Contractor.

**ARTICLE 57 ASSIGNMENT OF CONTRACT**

Contractor shall not assign, transfer, convey, sublet or otherwise dispose of the rights or title of interest of any or all of this contract without the prior written consent of the District. Any assignment or change of Contractor's name of legal entity without the written consent of the District shall be void. Any assignment of money due or to become due under this Contract shall be subject to a prior lien for services rendered or Material supplied for performance of Work called for under the Contract Documents in favor of all persons, firms, or corporations rendering such services or supplying such Materials to the extent that claims are filed pursuant to the Civil Code, the Code of Civil Procedure or the Government Code.

**GENERAL CONDITIONS**  
**SECTION F- LABOR AND CONSTRUCTION**

**ARTICLE 58 CHANGE IN NAME AND NATURE OF CONTRACTOR'S LEGAL ENTITY**

Should a change be contemplated in the name or nature of the Contractor's legal entity, the Contractor shall first notify the District in order that proper steps may be taken to have the change reflected on the Contract and all related documents. No change of Contractor's name or nature will affect District's rights under the Contract, including but not limited to the bonds.

**ARTICLE 59 ASSIGNMENT OF ANTITRUST ACTIONS**

Pursuant to Public Contract Code section 7103.5, in entering into a public works contract or subcontract to supply goods, services, or materials pursuant to a public works contract, Contractor or subcontractor offers and agrees to assign to the District all rights, title, and interest in and to all causes of action it may have under Section 4 of the Clayton Act (15 USC, Section 15) or under the Cartwright Act (Chapter 2 (commencing with Section 16700) of Part 2 of Division 7 of the Business and Professions Code), arising from the purchase of goods, services, or materials pursuant to this contract or any subcontract. This assignment shall be made and become effective at the time the District tenders final payment to the Contractor, without further acknowledgment by the parties.

**ARTICLE 60 PROHIBITED INTERESTS**

No District official or representative who is authorized in such capacity and on behalf of the District to negotiate, supervise, make, accept, or approve, or to take part in negotiating, supervising, making, accepting or approving any engineering, inspection, construction or material supply contract or any subcontract in connection with construction of the project, shall ARTICLE 11 be or become directly or indirectly interested financially in the Contract.

**ARTICLE 61 CONTROLLING LAW**

Notwithstanding any subcontract or other contract with any subcontractor, supplier, or other person or organization performing any part of the Work, this Contract shall be governed by the law of the State of California excluding any choice of law provisions.

**ARTICLE 62 JURISDICTION; VENUE**

Contractor and any subcontractor, supplier, or other person or organization performing any part of the Work agrees that any action or suits at law or in equity arising out of or related to the bidding, award, or performance of the Work shall be maintained in the Superior Court of Riverside County, California, and expressly consent to the jurisdiction of said court, regardless of residence or domicile, and agree that said court shall be a proper venue for any such action.

**ARTICLE 63 LAWS AND REGULATIONS**

- A. Contractor shall give all notices and comply with all laws, ordinances, rules and regulations bearing on conduct of work as indicated and specified. If Contractor observes that drawings and specifications are at variance therewith, it shall promptly notify the Engineer in writing and any necessary changes shall be adjusted as provided for in this Contract for changes in work. If Contractor performs any work knowing it to be contrary to such laws, ordinances, rules and

**GENERAL CONDITIONS**  
**SECTION F- LABOR AND CONSTRUCTION**

regulations, and without such notice to the Engineer, it shall bear all costs arising therefrom.

- B. Contractor shall be responsible for familiarity with the Americans with Disabilities Act ("ADA") (42 U.S.C. § 12101 et seq.). The Work will be performed in ARTICLE 11 compliance with ADA regulations.

**ARTICLE 64 PATENTS**

Contractor shall hold and save the District, officials, officers, employees, and authorized volunteers harmless from liability of any nature or kind of claim therefrom including costs and expenses for or on account of any patented or unpatented invention, article or appliance manufactured, furnished or used by Contractor in the performance of this contract.

**ARTICLE 65 OWNERSHIP OF CONTRACT DOCUMENTS**

All Contract Documents furnished by the District are District property. They are not to be used by Contractor or any subcontractor on other work nor shall Contractor claim any right to such documents. With exception of one complete set of Contract Documents, all documents shall be returned to the District on request at completion of the Work.

**ARTICLE 66 NOTICE OF TAXABLE POSSESSORY INTEREST**

In accordance with Revenue and Taxation Code section 107.6, the Contract Documents may create a possessory interest subject to personal property taxation for which Contractor will be ARTICLE 11 responsible.

**ARTICLE 67 SURVIVAL OF OBLIGATIONS**

All representations, indemnifications, warranties, and guarantees made in, required by, or given in accordance with the Contract Documents, as well as all continuing obligations indicated in the Contract Documents, will survive final payment, completion, and acceptance of the Work or termination or completion of the Contract or termination of the services of Contractor.

**EXHIBIT "A"**  
**CHANGE ORDER FORM**

**Valley-Wide Recreation and Park District**

*901 W. Esplanade Avenue  
San Jacinto, California*

**Contract Change Order #**

<b>Project:</b>	<b>Change Order No.:</b>		
	<b>Orig. Contract Amt.:</b> \$		Days
<b>Contract No.:</b>			
<b>Contractor:</b>	<b>Prev. Appvd. Changes:</b> \$		Days
<b>Owner:</b> Valley-Wide Recreation and Park District	<b>This Change:</b> \$		Days
	<b>Revised Contract Amt.:</b> \$		Days

This Change Order covers changes to the subject contract as described herein. The Contractor shall construct, furnish equipment and materials, and perform all work as necessary or required to complete the Change Order items for a lump sum price agreed upon between the Contractor and Valley-Wide Recreation and Park District, otherwise referred to as Owner.

Item No.	Description of Changes	Increase/ (Decrease) in Contract Amount	Contract Time Extension, Days
1			
2			
	<b>Totals</b>	\$	

This Contract Change Order consists of **2 pages** and any exhibits attached to this Contract Change Order shall not be part of the Contract Change Order unless specifically initiated by or on behalf of both the Contractor and the Valley-Wide Recreation and Park District.

Contract Change Order # \_\_\_\_\_ Page 1 of 2

The amount of the contract will be increased by the sum of \$\_\_\_\_\_ and the contract time shall be extended by working days. The undersigned Contractor approves the foregoing Change Order # as to the changes, if any, in the contract price specified for each item including any and all supervision costs and other miscellaneous costs relating to the change in work, and as to the extension of time allowed, if any, for completion of the entire work on account of said Change Order #. The Contractor agrees to furnish all labor and materials and perform all other necessary work, inclusive of the directly or indirectly related to the approved time extension, required to complete the Change order items. This document will become a supplement of the contract and all provisions will apply hereto. It is understood that the Change Order shall be effective when approved by the Owner.

Contractor accepts the terms and conditions stated above as full and final settlement of any and all claims arising out of or related to the subject of this Change Order and acknowledges that the compensation (time and cost) set forth herein comprises the total compensation due for the work or change defined in the Change Order, including all impact on any unchanged work. By signing this Change Order, the Contractor acknowledges and agrees that the stipulated compensation includes payment for all Work contained in the Change Order, plus all payment for any acceleration or interruption of schedules, extended overhead costs, delay, and all impact or cumulative impact on all Work under this Contract. The signing of this Change Order acknowledges full mutual accord and satisfaction for the change and that the stated time and/or cost constitute the total equitable adjustment owed the Contractor as a result of the change. The Contractor hereby releases and agrees to waive all rights, without exception or reservation of any kind whatsoever, to file any further claim or request for equitable adjustment of any type, for any reasonably foreseeable cause that shall arise out of, or as a result of, this Change Order and/or its impact on the remainder of the Work under the Contract.

Accepted:

\_\_\_\_\_  
(Signature) Contractor's Authorized Representative

\_\_\_\_\_  
Date

Recommended:

\_\_\_\_\_  
(Signature) **\*\*INSERT NAME, TITLE\*\***

\_\_\_\_\_  
Date

Approved:

\_\_\_\_\_  
(Signature) **\*\*INSERT NAME, TITLE\*\***

\_\_\_\_\_  
Date

Item No.	Justification for Change(s)
1	
2	

This Contract Change Order consists of **2 pages** and any exhibits attached to this Contract Change Order shall not be part of the Contract Change Order unless specifically initiated by or on behalf of both the Contractor and the Valley-Wide Recreation and Park District.

Contract Change Order #

Page 2 of 2



**VALLEY-WIDE RECREATION**  
**REGIONAL PARK ACCESSIBILITY IMPROVEMENT PROJECT**  
**SECTION 00100 SC-SPECIAL CONDITIONS**  
**SPECIAL PROVISIONS**

**SC-01. SCOPE OF WORK**

Under these specifications the Contractor shall perform all work for the Regional Park Accessibility Improvement Project in accordance with these specifications and the contract drawings. The work generally consists but not limited to the following:

- Removing existing concrete, asphalt, base, vegetation, signs and other items.
- Constructing concrete curb and gutter, sidewalk, and ADA ramps
- Parking lot improvements
- Signing and striping

**General**

1. All work shall comply with County of Riverside referenced standards on bidding sheets and Valley-Wide Recreation and Park District standards and specifications, which can be viewed at <https://www.gorecreation.org/standards-and-specifications>.
2. Contractor shall schedule a pre-job meeting 7 days prior to commencement of work.
3. Contractors shall provide submittals sheets of all proposed material prior to pre-job meeting.
4. All work shall be inspected by District. No trenches are permitted to be covered until approval by the District is obtained.
5. Contractor shall provide a detailed project schedule with durations of all scope of work.
6. Contractor shall be responsible for traffic control throughout the duration of all work. Traffic control must be provided per City of San Jacinto requirements including but not limited to an approved traffic control plan.
7. Contractor shall provide an encroachment permit for work within City of San Jacinto public right-of-way.
8. Contractor shall clean the project daily.
9. Contractor shall submit daily reports each day to District's representative.
10. Contractor shall maintain all new landscape areas for a period not less than 30 days from project installation completion acceptance by the District. Maintenance period does not commence until written approval is provided by the District.
11. Contractor acknowledges that roots and other organic material is present within all areas of work and no additional compensation will be given for time required to complete scope of work within said conditions.

12. Retention shall be withheld per contract requirements until final acceptance has been provided by the District.

**SC-02. SAFETY PROGRAM**

Safety of all activities in connection with the work is of paramount and overriding importance.

Please note that the District reserves the right to suspend the work wholly or in part, for any time period as the district representative deems necessary, due to unresolved safety disputes.

No additional compensation or contract time will be allowed for the period the work is wholly or in part suspended.

Should the contract continue with the disputed work after having received a written notice of suspension, any work performed by the contractor during the suspension shall be considered as having been done by the contractor at the contractor's own risk as a volunteer, and shall not entitle the contractor to compensation or any other rights under the contract.

The Contractor shall conform to all applicable occupational safety and health standards, rules, regulations and orders established by local agencies, State of California, and California Division of Occupational Safety and Health Construction Safety Regulations (Cal Osha), including obtaining permits required by California Code of Regulations, Title 8, Sections 341 and 341 (a).

**SC-03. PERFORMANCE AND PAYMENT BONDS**

Pursuant to Section 995.660(a) of the Code of Civil Procedure, the Contractor shall submit the following documents with performance and payment bonds:

1. The original, or certified copy of the unrevoked appointment, power of attorney, bylaws, or other instrument entitling or authorizing their person who executed the bond to do so; and
2. A certified copy of the certificate of authority of the insurer issued by the State of California's Insurance Commissioner.

NO PAYMENT SHALL BE MADE UNTIL THE BONDS ARE APPROVED.

**SC-04. LOCATION OF CONTRACT WORK SITE**

The contract work site is located at Valley-Wide Regional Park – 901 W. Esplanade Avenue in the City of San Jacinto, California.

**SC-05. LIQUIDATED DAMAGES**

The fixed liquidated damages amount for each calendar day of unauthorized delay in completion of the work is hereby established at one thousand dollars (\$250) per calendar day.

**SC-06. INSURANCE**

At the times during the life of this contract, Contractor and his subcontractors shall procure and maintain Commercial Liability, Automobile Liability and Workers Compensation.

**SC-07. PRECONSTRUCTION CONFERENCE**

A Pre-job Conference shall be scheduled prior to the start of the project. District and Contractor representative shall be present.

**SC-08. TRAFFIC CONTROL PLAN**

It shall be the Contractor's responsibility to implement the approved traffic control plans. Contractor shall purchase or rent and maintain traffic warning signs, barricades, flagmen and other traffic control devices as required and to maintain traffic flow, as required by agencies having jurisdiction over the roadways in the work area. The cost for this work shall be included in Bid Prices. No additional compensation and time extension will be provided.

**SC-09. EQUIPMENT AND MATERIAL STORAGE**

It is the Contractor's responsibility to legally store equipment and material associated with the performance of the work. If the Contractor has arranged for temporary storage on private property outside of the public-right-of-way, the Contractor shall provide to the District a copy of the written agreement between the landowner and the Contractor.

**SC-10. NOISE RESTRICTIONS**

- A. Contractor shall use only such equipment on the Work and in such state of repair so that the emission of sound therefrom is within the noise tolerance level of that equipment as established by Cal/OSHA.
- B. Contractor shall comply with the most restrictive of the following: (1) local sound control and noise level rules, regulations and ordinances and (2) the requirements contained in these Contract Documents, including hours of operation requirements.
- C. No internal combustion engine shall be operated on the Project without a muffler of the type recommended by the manufacturer. Should any muffler or other control device sustain damage or be determined to be ineffective or defective, the Contractor shall promptly remove the equipment and shall not return said equipment to the job until the device is repaired or replaced. Said noise and vibration level requirements shall apply to all equipment on the job or related to the job, including but not limited to, trucks, transit mixers or transit equipment that may or may not be owned by the Contractor.

**SC-11. COORDINATION WITH OTHER CONTRACTORS**

[NOT USED]

**SC-12. MODIFICATION OF HOURS OF WORK**

[NOT USED]

**SC-13. DESIGNATION OF DISTRICT'S REPRESENTATIVE**

Unless otherwise modified by District, Districts' Representative shall be James Salvador and can be contacted at (951) 654-1505 or [JamesS@GoRecreation.org](mailto:JamesS@GoRecreation.org).

**SC-14. ENGINEER OF RECORD.**

For purposes of this Project, the Engineer of Record or Engineer shall be:

Blaine A. Womer Civil Engineering

**END OF SPECIAL CONDITIONS**

# VALLEY WIDE RECREATION AND PARK DISTRICT ACCESSIBILITY IMPROVEMENT PLAN FOR REGIONAL PARK

## GENERAL NOTES

- ALL WORK TO BE PERFORMED PER RIVERSIDE COUNTY TRANSPORTATION STANDARDS.
- THE CONTRACTOR IS REQUIRED TO REMOVE ALL CONFLICTING STRIPING AND LEGENDS BY WET SANDBLASTING.
- ALL STRIPING & LEGENDS SHALL BE REPLACED IN-KIND EXCEPT WHERE NOTED OTHERWISE. ALL STRIPING TO BE PAINT (TWO COATS) AND ALL MARKINGS (INCLUDING CROSSWALKS) TO BE THERMOPLASTIC. ALL STRIPING AND PAVEMENT MARKINGS TO BE PER CALTRANS STANDARDS.
- IT IS THE CONTRACTOR'S RESPONSIBILITY TO PROTECT THE NEW WORK FROM VANDALISM UNTIL THE IMPROVEMENTS HAVE BEEN ACCEPTED BY THE DISTRICT AND A NOTICE OF COMPLETION HAS BEEN FILED.
- CONTRACTOR SHALL CONTACT UNDERGROUND SERVICE ALERT OF SOUTHERN CALIFORNIA AND OTHER UTILITY COMPANIES AS NEEDED TO COORDINATE FOR PROTECTION AND/OR ADJUSTMENTS OF UTILITIES, AS REQUIRED.
- CONTRACTOR TO VISIT THE SITE(S) AND FAMILIARIZE HIMSELF WITH THE WORK AND AREA PRIOR TO BIDDING.
- ANY DEVIATION FROM THESE PLANS IF PROPOSED BY THE CONTRACTOR MUST MEET DISTRICT'S APPROVAL. THE CONTRACTOR IS RESPONSIBLE TO REIMBURSE THE DISTRICT FOR ANY RELATED COST TO THE DISTRICT ASSOCIATED WITH SUCH CHANGE. IN THIS EVENT, NO INCREASE IN CONTRACTOR'S COST WILL BE ACCEPTABLE.
- CONTRACTOR SHALL REPLACE ALL STRIPING, LEGENDS, AND SIGNS IF THEY ARE DAMAGED DURING CONSTRUCTION AT NO EXTRA COST TO THE DISTRICT.

## AMERICANS WITH DISABILITIES NOTES

- ALL GRADE SLOPES SHOWN ON THIS PLAN WERE DESIGNED AT OR BELOW MAXIMUMS ALLOWED BY THE AMERICANS WITH DISABILITY ACT ACCESS GUIDE (A.D.A.A.G.) IN ORDER TO ALLOW FOR CONSTRUCTION TOLERANCES. IT IS THE CONTRACTOR'S RESPONSIBILITY TO FAMILIARIZE THEMSELVES WITH A.D.A.A.G. AND IN THE EVENT THAT A DESIGN QUESTION SHOULD ARISE, OR A FIELD CONDITION PRESENT ITSELF THAT IS DIFFERENT THAN SHOWN ON THESE PLANS, WORK SHOULD CEASE AND THE ENGINEER SHOULD BE NOTIFIED SO THAT AN ACCEPTABLE SOLUTION CAN BE DETERMINED.
- THE CONTRACTOR IS ADVISED TO CAREFULLY CHECK ALL PHASES OF WORK RELATING TO A.D.A.A.G. ACCESS FOR THIS PROJECT, SINCE THE CODE DOES NOT ALLOW FOR A CONSTRUCTION TOLERANCE, ANY CONSTRUCTION THAT EXCEEDS MAXIMUM OR MINIMUM DIMENSIONS AND SLOPE GRADES AS CALLED OUT BY A.D.A.A.G. ARE SUBJECT TO REJECTION BY THE CITY OF SAN JACINTO AND MAY BE REQUIRED TO BE REMOVED AND REPLACED.
- SINCE THE CIVIL ENGINEER OR SURVEYOR CANNOT CONTROL THE EXACT METHODS OR MEANS USED BY THE GENERAL CONTRACTOR OR THEIR SUB-CONTRACTOR DURING GRADING AND CONSTRUCTION OF THE PROJECT, THE CIVIL ENGINEER OR SURVEYOR ASSUMES NO RESPONSIBILITY FOR FINAL ACCEPTANCE OF A.D.A.A.G. RELATED ITEMS OF THIS PROJECT BY THE CITY OF SAN JACINTO, ANY OTHER AUTHORITY OR OTHER AFFECTED PARTIES.
- THIRD PARTY A.D.A. SPECIALIST SHALL PROVIDE A.D.A. CERTIFICATION FOR ALL PATH OF TRAVEL AND SITE AMENITIES.

COMPLIANCE WITH A.D.A.A.G. CONSTRUCTION REQUIREMENTS WILL BE THE SOLE RESPONSIBILITY OF THE GENERAL CONTRACTOR AND THEIR SUB-CONTRACTORS.

## CONSTRUCTION NOTES

- SAWCUT EXIST. CONCRETE..... 492 L.F.
- REMOVE EXIST. CONCRETE..... 18,424 S.F.
- CONSTRUCT 4" THICK CONCRETE WALKWAY PER RIV. CO. STD. NO. 401..... 19,330 S.F.
- ADA ACCESSIBLE PARKING LOT STRIPING PER CBC 2019 SEC. 11B-502 FIG. 11B-502.2, 11B-502.3 & 11B-502.3.3..... L.S.
- JOIN EXIST. SURFACE FLUSH..... L.S.
- SLURRY SEAL BETWEEN CONCRETE AND PAVEMENT..... 240 L.F.
- CONSTRUCT ADA ACCESSIBLE RAMP PER RIV. CO. STD. 403, CASE 'A'..... 268 S.F.
- REMOVE EXISTING CONCRETE CURB..... 397 L.F.
- SAWCUT EXIST. AC PAVEMENT..... 237 L.F.
- REMOVE EXIST. AC PAVEMENT..... 22,476 S.F.
- INSTALL MIN. 3" AC OVER 4" CLASS II AGG. BASE..... 1,612 S.F.
- CONSTRUCT 3.0' WIDE CONCRETE RIBBON GUTTER PER DETAIL THIS SHEET..... 1,704 S.F.
- REPLACE STRIPING DESTROYED BY PAVEMENT REMOVAL..... L.S.
- PAINT ADA PARKING SPACE STRIPING AND LEGEND PER 2019 CBC SECTION 11B-502..... L.S.
- INSTALL ADA PARKING SPACE SIGNAGE PER 2019 CBC SECTION 11B-502.6..... 14 EA.
- JOIN EXISTING AC PAVEMENT PER JOIN DETAIL THIS SHEET..... 42 L.F.
- INSTALL TRUNCATED DOWNS PER 2019 CBC SEC. 11B-705..... 948 S.F.
- PAINT 'NO PARKING' IN 12" HIGH WHITE LETTERS..... L.S.
- PAINT RED CROSS HATCH FOR NO PARKING AREA..... L.S.
- REMOVE & REPLACE EXISTING CHAINLINK FENCE..... 92 L.F.
- INSTALL BROOKS PRODUCTS 36" LONG CONCRETE WHEEL STOP..... 14 EA.
- INSTALL CONCRETE STEP, HEIGHT AS SHOWN..... 4 L.F.
- REMOVE EXISTING AC PAVEMENT RAMP..... 325 S.F.
- GRIND AND OVERLAY EXISTING AC, MIN. 0.15"..... 3,184 S.F.
- PROTECT IN PLACE EXISTING 4" DRAIN PIPE..... 3 EA.
- REMOVE EXISTING ADA PARKING SPACE SIGN..... L.S.
- CONSTRUCT ADA ACCESSIBLE RAMP PER RIV. CO. STD. 403, CASE 'B'..... 680 S.F.
- PROTECT IN PLACE EXISTING CONCRETE CURB..... L.S.
- INSTALL 6" THICK, 2.0' HIGH CUT OFF WALL..... 9 L.F.
- INSTALL RIP RAP, 50LB ROCK, MIN. 2" THICK..... 71 S.F.
- INSTALL HANDRAIL PER 2019 CBC, SEC. 11B-505..... 23 L.F.
- REMOVE AND REPLACE EXISTING PARKING LOT STRIPING AS SHOWN..... L.S.
- CONSTRUCT 6" TYPE D CURB PER RIV. CO. STD. NO. 204..... 501 L.F.
- CONSTRUCT CONCRETE ACCESS RAMP..... 444 S.F.
- INSTALL 3" HIGH WHEEL GUIDE & HAND RAIL PER 2019 CBC SEC. 11B-505 AND DETAILS SHEET 9..... 107 L.F.
- REMOVE EXISTING CHAINLINK FENCE..... 17 L.F.
- INSTALL INTERNATIONAL SYMBOL OF ACCESSIBLE ROUTE SIGN PER 2019 CBC FIGURE 11B-703.7.2.1 AND DETAIL SHEET 4..... 6 EA.
- PROTECT IN PLACE EXISTING LIGHT STANDARD..... 1 EA.
- REMOVE EXISTING BOX INLET..... 44 EA.
- RELOCATE EXISTING CONCRETE WHEEL STOPS..... 1 EA.
- RELOCATE EXISTING BOLLARD BY DIRECTION OF OWNER..... 1 EA.
- CONSTRUCT CONCRETE DRIVE APPROACH, 6" THICK, X=3'..... 90 S.F.
- CONSTRUCT UNDER SIDEWALK DRAIN PER RIV. CO. STD. NO. 309..... 8 L.F.
- INSTALL 5.5" THICK RCC PAVEMENT. SECTION TO BE VERIFIED BY THE PROJECT GEOTECHNICAL ENGINEER..... 21,391 S.F.
- CONSTRUCT COMMERCIAL DRIVEWAY PER RIV. CO. STD. NO. 207A..... 637 S.F.
- REMOVE EXISTING TREE, DIA. AS SHOWN..... 1 EA.
- RELOCATE EXISTING UTILITY BOX..... 1 EA.
- RELOCATE EXISTING PARKING LOT SIGN BEHIND PROPOSED SIDEWALK..... 1 EA.
- PROTECT IN PLACE EXISTING 4" BLOW OFF..... 61 S.F.
- CONSTRUCT 8.0' WIDE CONCRETE RIBBON GUTTER PER DETAIL THIS SHEET..... 49 L.F.
- CURB FACE TRANSITION, 6" TO 0"..... 49 L.F.
- REMOVE EXISTING ADA LEGEND AND SPACE STRIPING AND RE-STRIPING FOR STANDARD PARKING SPACE..... L.S.

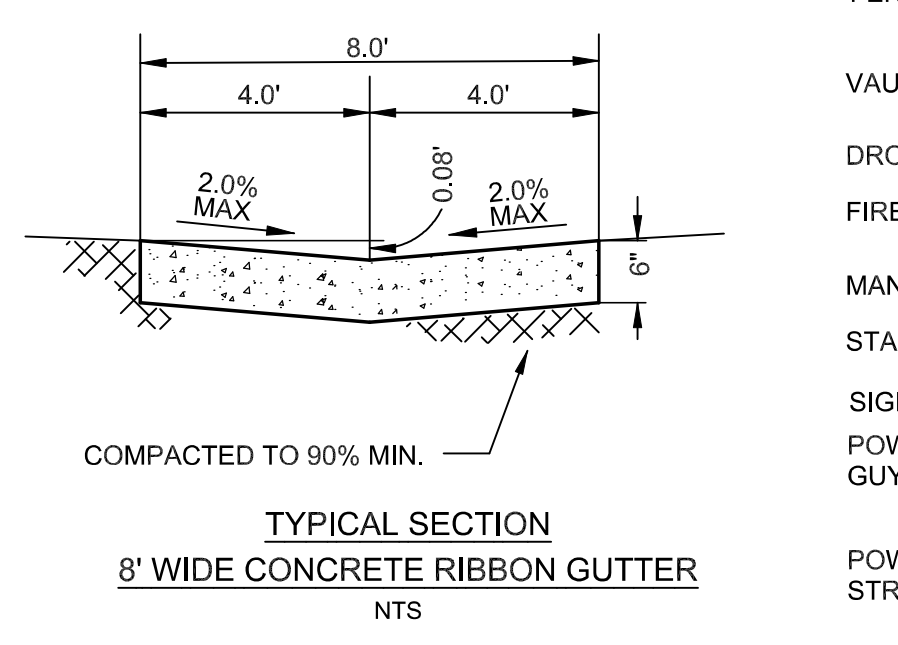
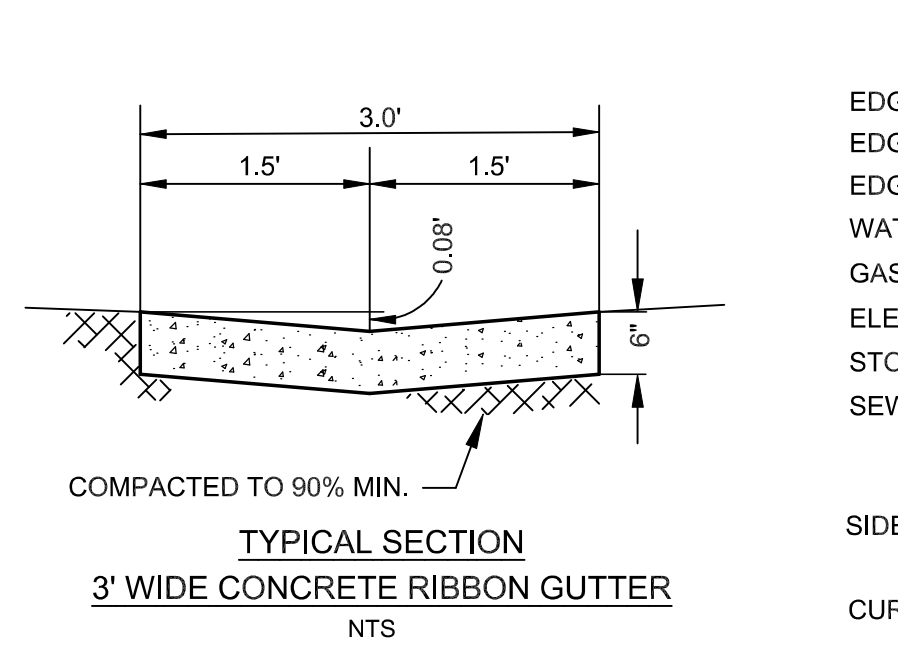
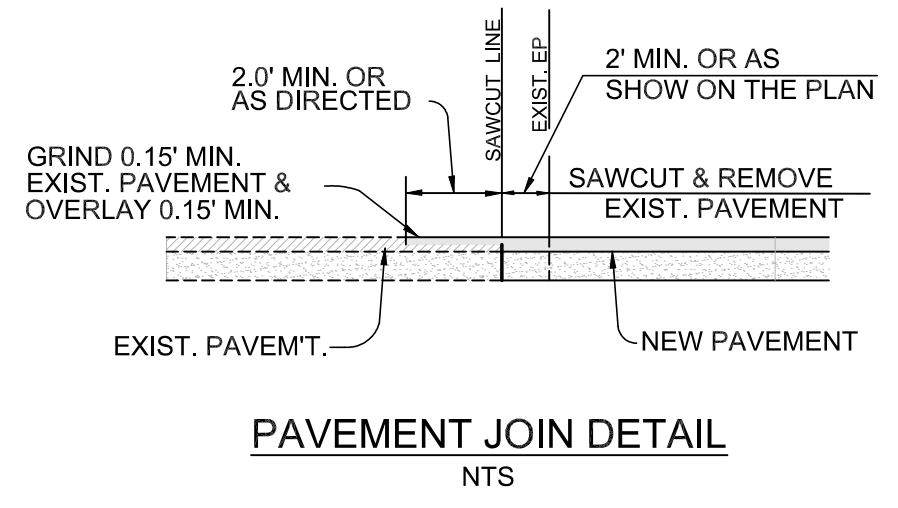
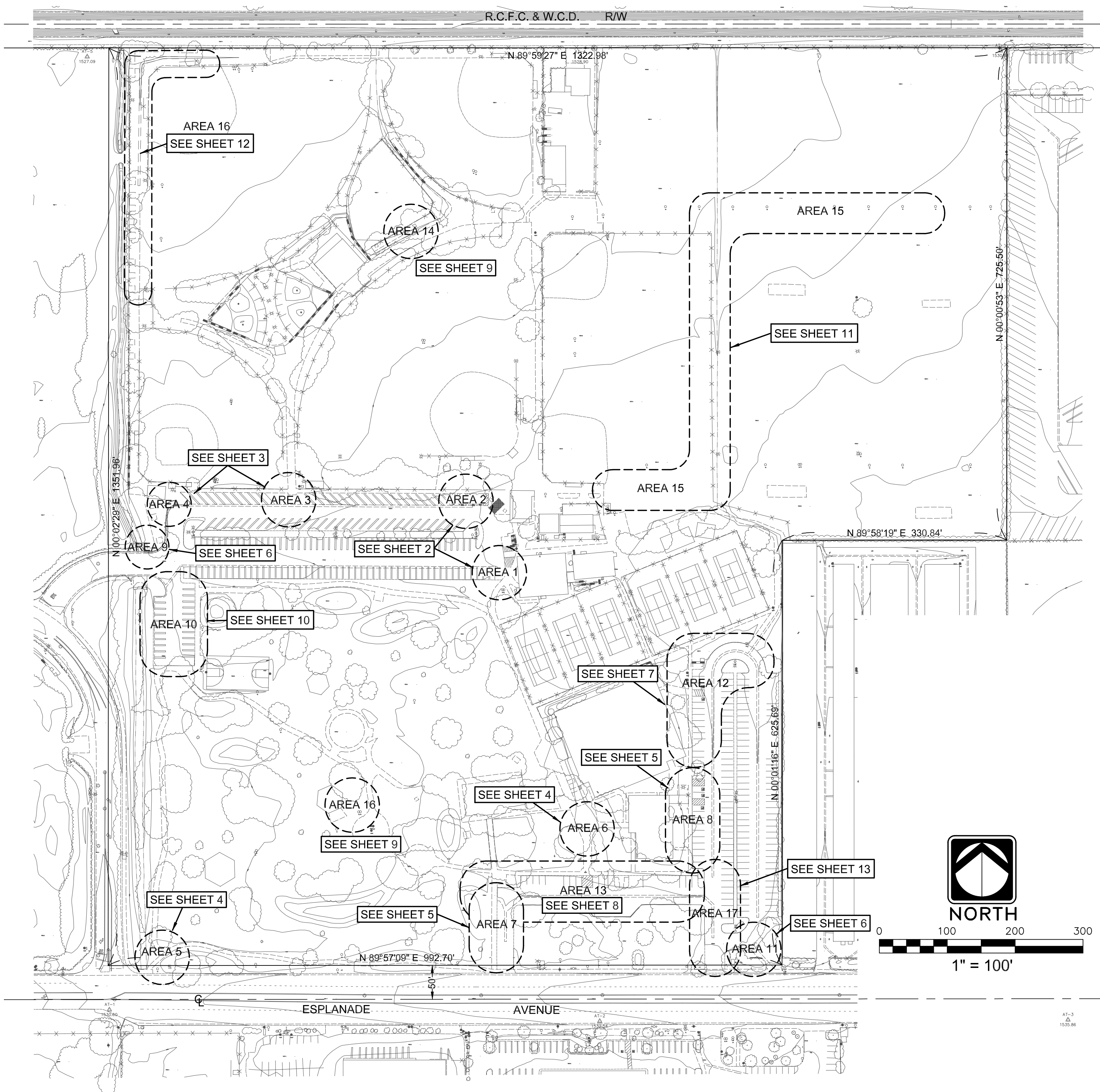
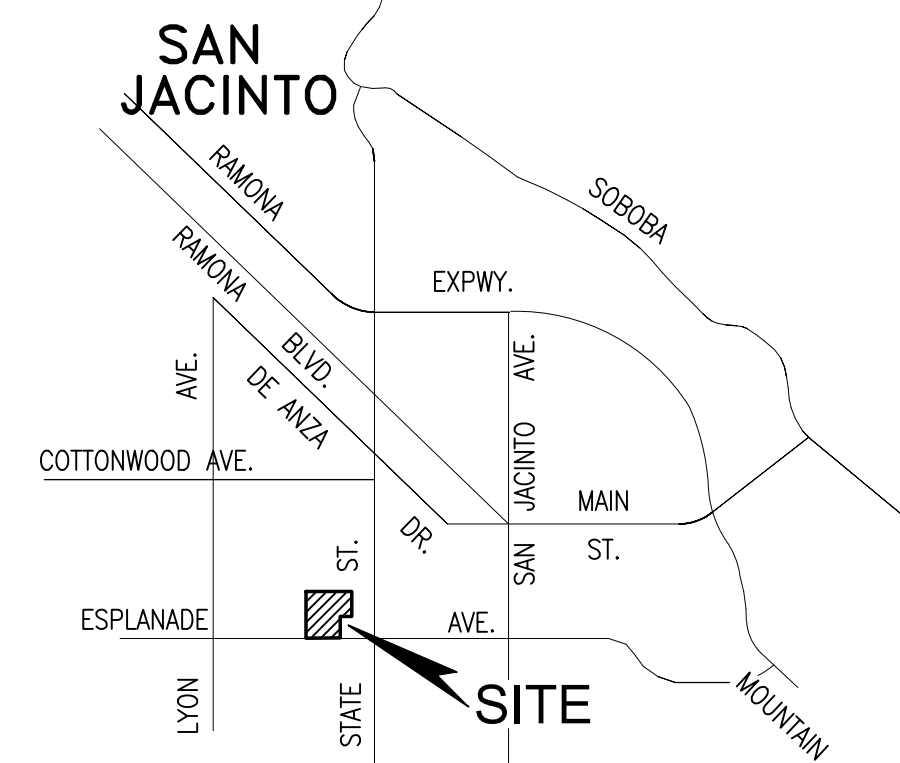

### LEGEND

EDGE OF CONC.	---
EDGE OF ASPH.	---
EDGE OF DIRT	---
WATER LINE (SIZE NOTED)	---W---
GAS LINE (SIZE NOTED)	---G---
ELECTRIC LINE	---E---
STORM DRAIN (SIZE NOTED)	---SD---
SEWER LINE (SIZE NOTED)	---S---

SIDEWALK	---
CURB AND GUTTER	---
FENCE	---
VAULT	---
DROP INLET	---
FIRE HYDRANT	---
MANHOLE	---
STANDPIPE	---
SIGN	---
POWER POLE	---
GUY WIRE	---
POWER POLE	---
STREET LIGHT	---
STOP LIGHT	---
MISCELLANEOUS UTILITIES	---
CONCRETE SURFACE	---
ASPHALT SURFACE	---
REMOVE & REPLACE EXISTING CONCRETE	---
REMOVE & REPLACE EXISTING PAVEMENT	---

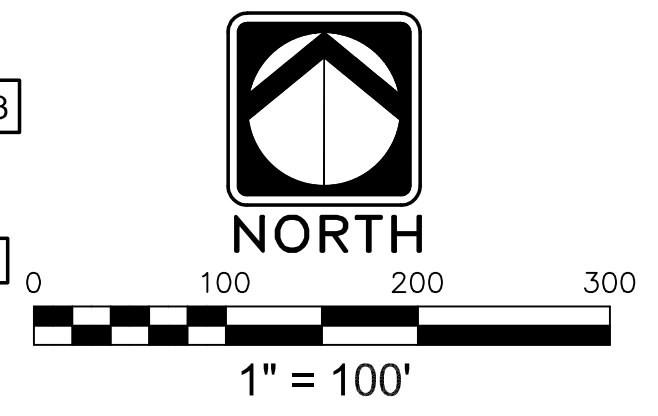

## PROJECT AREA INDEX MAP

**BASIS OF BEARINGS:**  
THE BASIS OF BEARINGS FOR THIS PROJECT IS THE CENTERLINE OF ESPLANADE AVENUE AS SHOWN BY RECORD OF SURVEY MAP ON FILE IN BOOK 60, PAGES 28 THROUGH 30 OF RECORDS OF SURVEY, RIVERSIDE COUNTY RECORDS, TAKEN AS N 89°57'09" E.

**BENCHMARK**  
RIVERSIDE COUNTY BENCHMARK H-8-3 AT THE SW CORNER OF STATE STREET AND SEVENTH STREET. AN ALUMINUM DISK SET FLUSH IN A 10" CONCRETE POST, UP 0.2' ELEV.=1532.71 (NAVD 88)

DATE	BY	MARK	REVISIONS	APPR. DATE
DESIGNED BY:	ENGINEER		DRAWN BY:	CITY
			CHECKED BY:	

APPROVED BY: \_\_\_\_\_ DATE: \_\_\_\_\_

PREPARED BY: \_\_\_\_\_ DATE: \_\_\_\_\_

R.C.E. NO. 46354

SCALE AS SHOWN

DATE OCT, 2018

BENCHMARK: SEE ABOVE RIGHT

VALLEY WIDE RECREATION AND PARK DISTRICT  
ACCESSIBILITY IMPROVEMENT PLAN  
FOR  
REGIONAL PARK  
TITLE SHEET

FOR \_\_\_\_\_ W.O. \_\_\_\_\_

SHEET NO.  
**1**  
OF 13 SHEETS  
FILE NO.

CONSTRUCTION NOTES

1. SAWCUT EXIST. CONCRETE.
2. REMOVE EXIST. CONCRETE.
3. CONSTRUCT 4" THICK CONCRETE WALKWAY PER RIV. CO. STD. NO. 401.
5. JOIN EXIST. SURFACE FLUSH.
6. SLURRY SEAL BETWEEN CONCRETE AND PAVEMENT.
9. SAWCUT EXIST. AC PAVEMENT.
10. REMOVE EXIST. AC PAVEMENT.
11. INSTALL MIN. 3" AC OVER 4" CLASS II AGG. BASE.
13. REPLACE STRIPING DESTROYED BY PAVEMENT REMOVAL.
14. PAINT ADA PARKING SPACE STRIPING AND LEGEND PER 2019 CBC SECTION 11B-502.
15. INSTALL ADA PARKING SPACE SIGNAGE PER 2019 CBC SECTION 11B-502.6.
16. JOIN EXISTING AC PAVEMENT PER JOIN DETAIL SHEET 1.
17. INSTALL TRUNCATED DOMES PER 2019 CBC SEC. 11B-705.
18. PAINT 'NO PARKING' IN 12" HIGH WHITE LETTERS.
20. REMOVE & REPLACE EXISTING CHAINLINK FENCE.
21. INSTALL BROOKS PRODUCTS 36" LONG CONCRETE WHEEL STOP.
52. REMOVE EXISTING ADA LEGEND AND SPACE STRIPING AND RE-STRIP FOR STANDARD PARKING SPACE

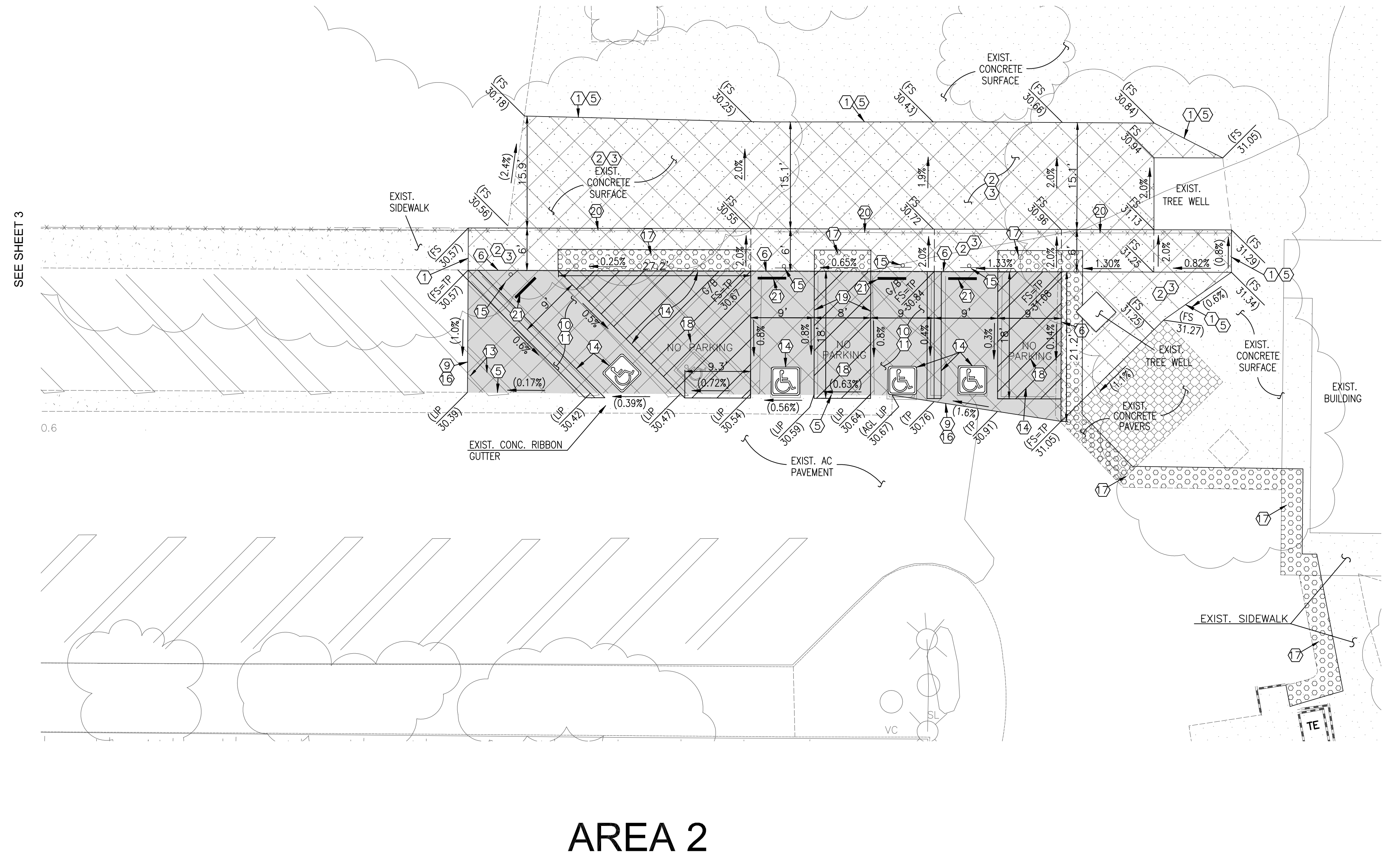
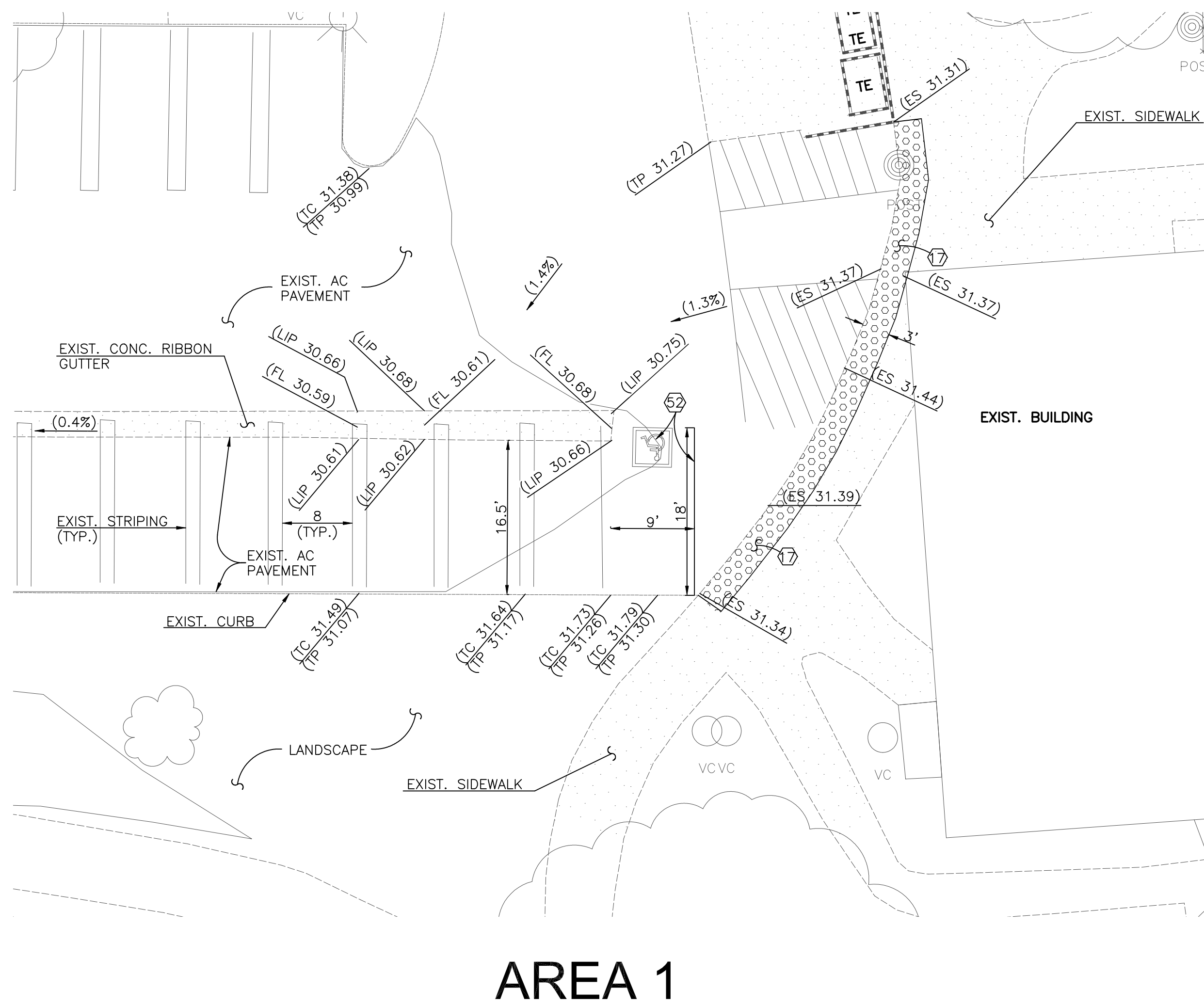
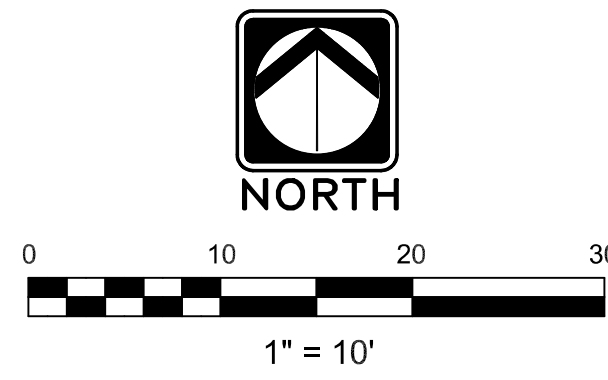

DATE	BY	MARK	REVISIONS	APPR. DATE
DESIGNED BY:	ENGINEER	DRAWN BY:	CHECKED BY:	CITY

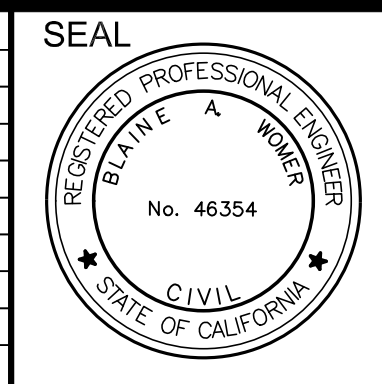

APPROVED BY: \_\_\_\_\_ DATE: \_\_\_\_\_

R.C.E. NO. \_\_\_\_\_ EXP. DATE \_\_\_\_\_

PREPARED BY: \_\_\_\_\_ DATE: \_\_\_\_\_

R.C.E. NO. \_\_\_\_\_ EXP. DATE \_\_\_\_\_

**B A W**  
**BLAINE A. WOMER**  
 CIVIL ENGINEERING

• PLANNING  
 • SURVEYING  
 • CIVIL ENGINEERING  
 • PUBLIC WORKS

SCALE: \_\_\_\_\_  
 BENCHMARK: \_\_\_\_\_

VALLEY WIDE RECREATION / PARK DISTRICT  
 ACCESSIBILITY IMPROVEMENT PLAN  
 PROJECT AREAS 1 & 2

FOR \_\_\_\_\_ W.O. \_\_\_\_\_

SHEET NO.  
**2**  
 OF 13 SHEETS  
 FILE NO.

CONSTRUCTION NOTES

1. SAWCUT EXIST. CONCRETE.
2. REMOVE EXIST. CONCRETE.
5. JOIN EXIST. SURFACE FLUSH.
7. CONSTRUCT ADA ACCESSIBLE RAMP PER RIV. CO. STD. 403, CASE 'A'.
8. REMOVE EXISTING CONCRETE CURB.
9. SAWCUT EXIST. AC PAVEMENT.
10. REMOVE EXIST. AC PAVEMENT.
11. INSTALL MIN. 3" AC OVER 4" CLASS II AGG. BASE.
14. PAINT ADA PARKING SPACE STRIPING AND LEGEND PER 2019 CBC SECTION 11B-502.
15. INSTALL ADA PARKING SPACE SIGNAGE PER 2019 CBC SECTION 11B-502.6
16. JOIN EXISTING AC PAVEMENT PER JOIN DETAIL SHEET 1.
17. INSTALL TRUNCATED DOMES PER 2019 CBC SEC. 11B-705.
18. PAINT 'NO PARKING' IN 12" HIGH WHITE LETTERS.
19. PAINT RED CROSS HATCH FOR NO PARKING AREA.

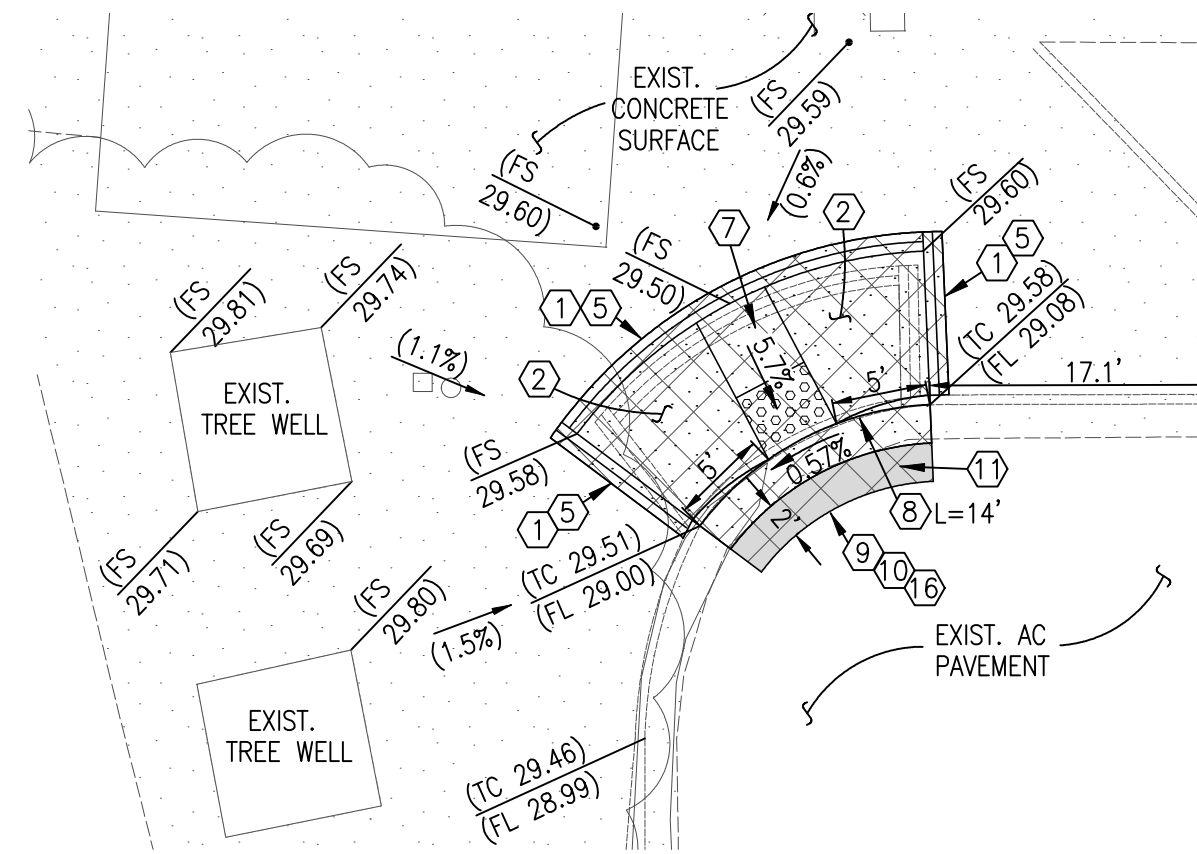
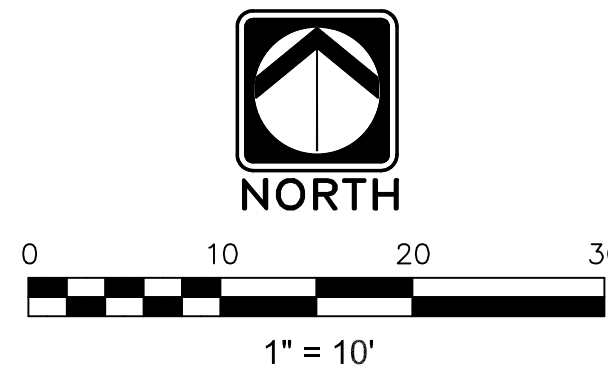

AREA 4

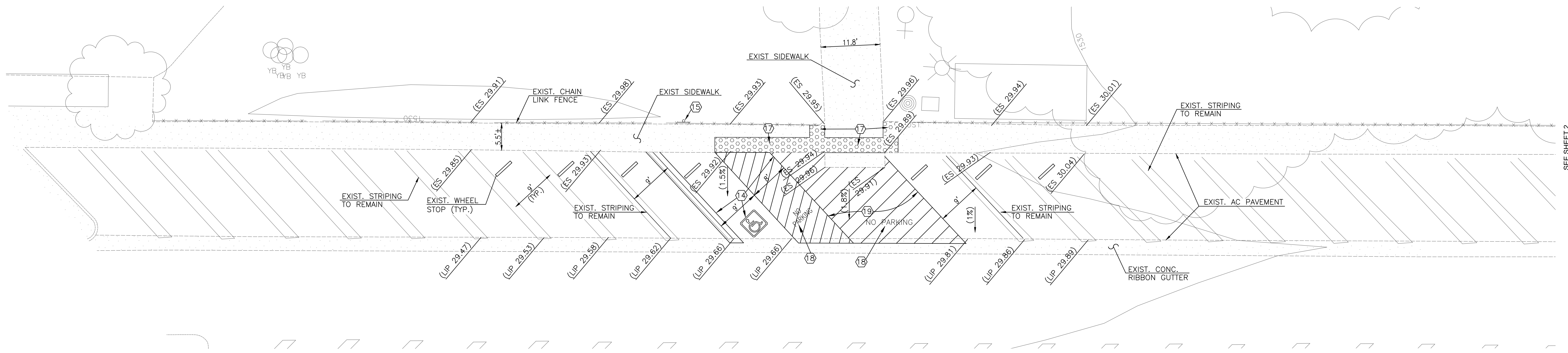

AREA 3

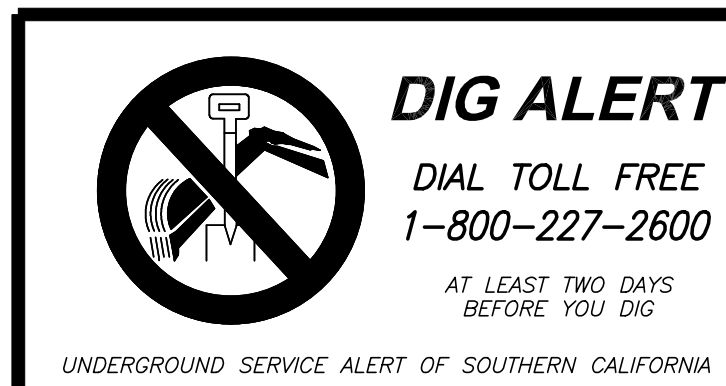

DATE	BY	MARK	REVISIONS	APPR. DATE
DESIGNED BY:	DRAWN BY:	CHECKED BY:		

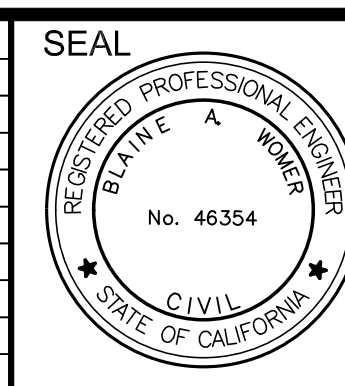

APPROVED BY:	DATE
R.C.E. NO.	EXP. DATE
PREPARED BY:	DATE
R.C.E. NO.	EXP. DATE

**B A W**  
**BLAINE A. WOMER**  
 CIVIL ENGINEERING

• PLANNING  
 • SURVEYING  
 • CIVIL ENGINEERING  
 • PUBLIC WORKS

Hermet, CA 92544, 41555 E. Florida Ave., Suite G, Phone (951)658-1727 Fax (951)658-2347  
 Park City, UT 84096, 5133 Cove Canyon Dr., #302, Phone/Fax (435)815-1489

SCALE: \_\_\_\_\_  
 DATE: \_\_\_\_\_

BENCHMARK: \_\_\_\_\_

VALLEY WIDE RECREATION / PARK DISTRICT  
 ACCESSIBILITY IMPROVEMENT PLAN  
 PROJECT AREAS 3 & 4

FOR: \_\_\_\_\_ W.O.: \_\_\_\_\_

SHEET NO.  
**3**  
 OF 13 SHEETS  
 FILE NO.

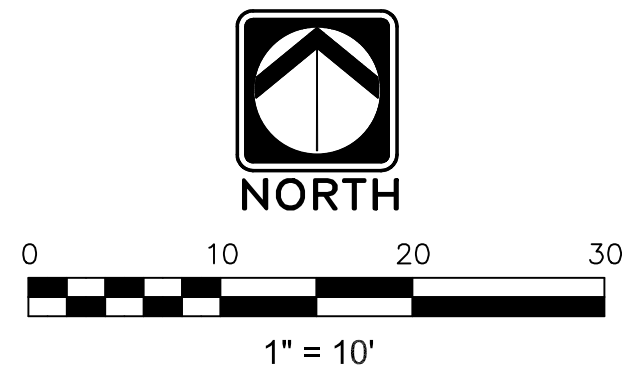

- CONSTRUCTION NOTES**
1. SAWCUT EXIST. CONCRETE.
  2. REMOVE EXIST. CONCRETE.
  3. CONSTRUCT 4" THICK CONCRETE WALKWAY PER RIV. CO. STD. NO. 401.
  5. JOIN EXIST. SURFACE FLUSH.
  37. INSTALL INTERNATIONAL SYMBOL OF ACCESSIBLE ROUTE SIGN PER 2019 CBC FIGURE 11B-703.7.2.1 AND DETAIL THIS SHEET.

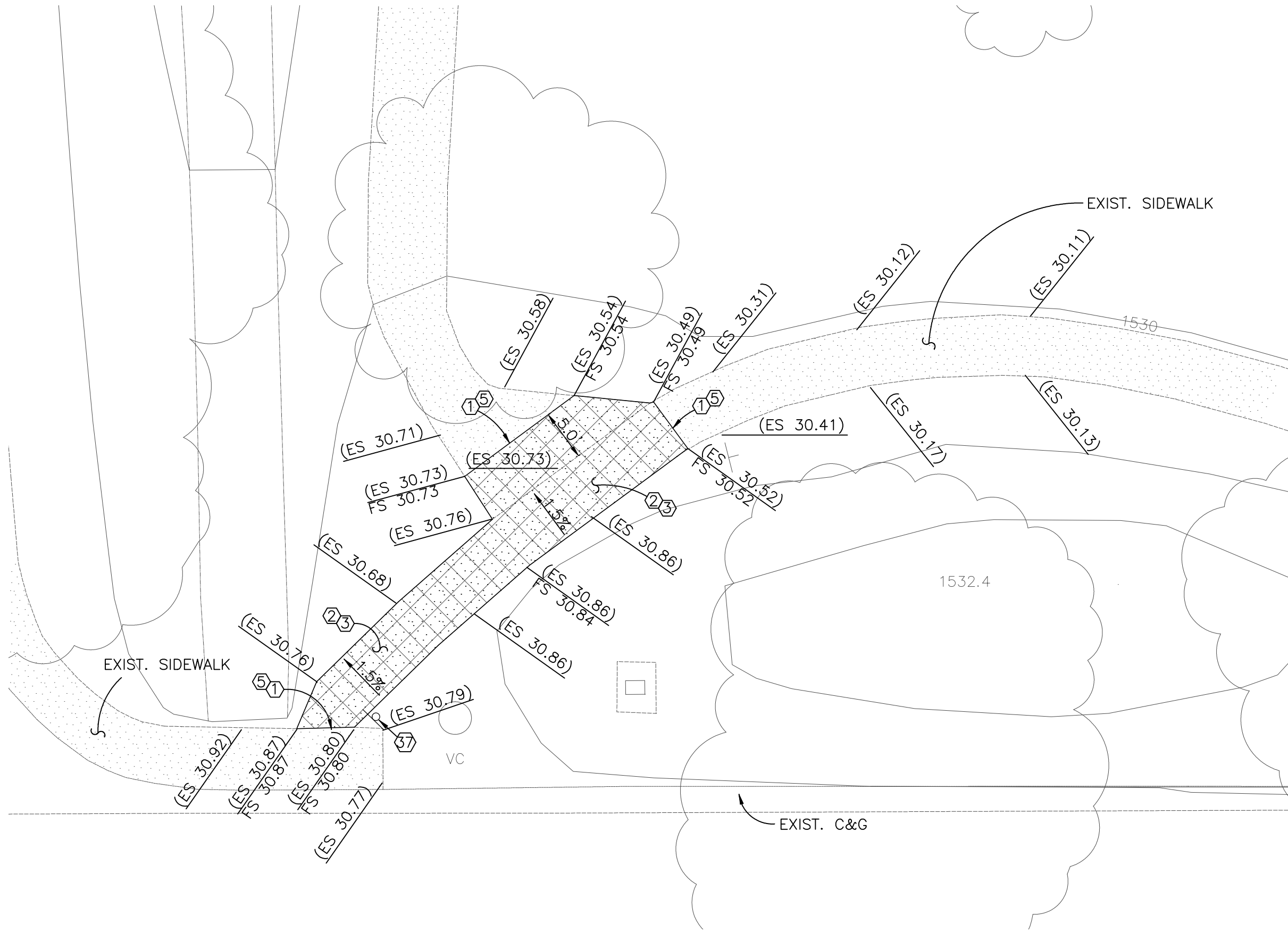

**AREA 5**

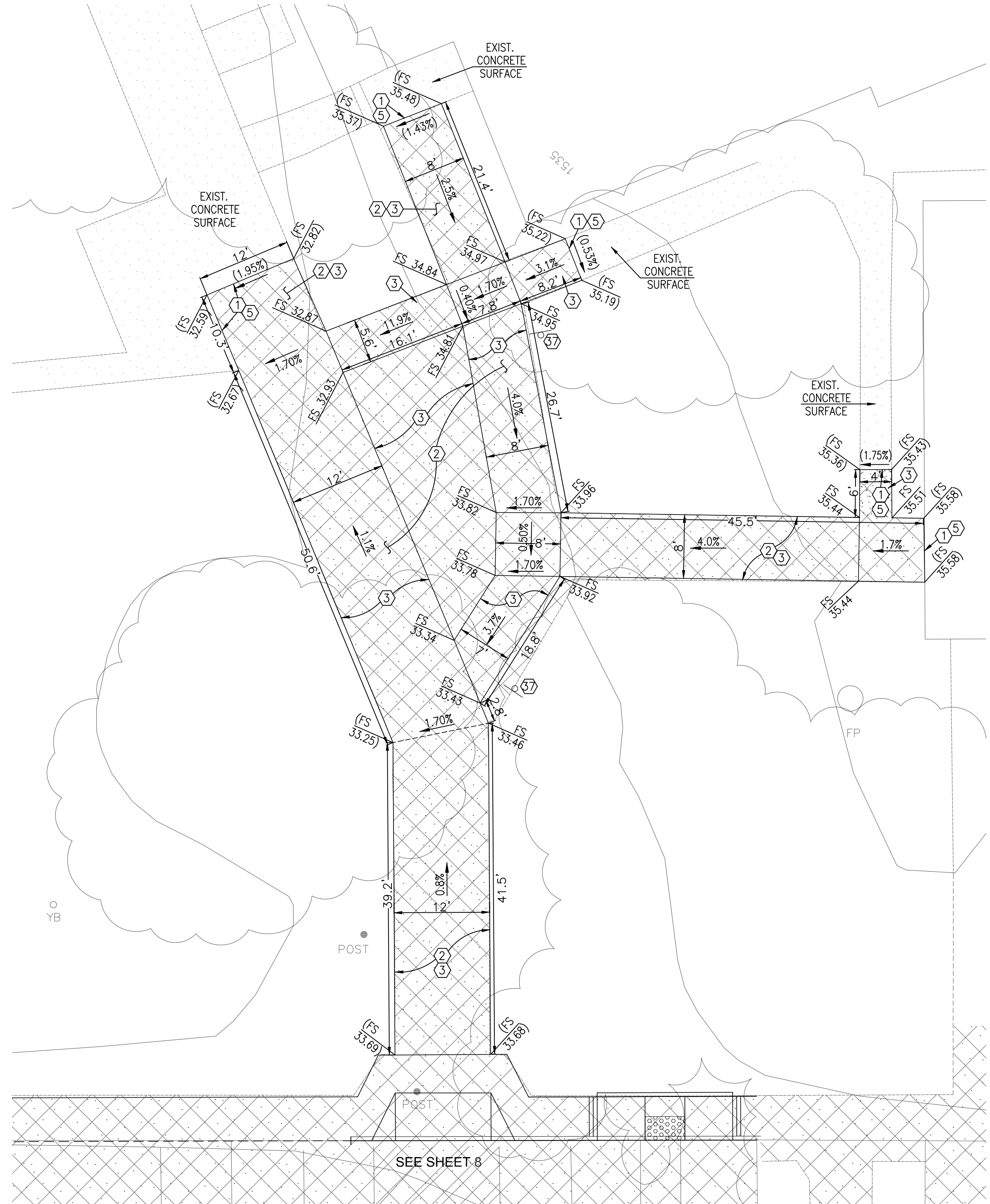

**AREA 6**

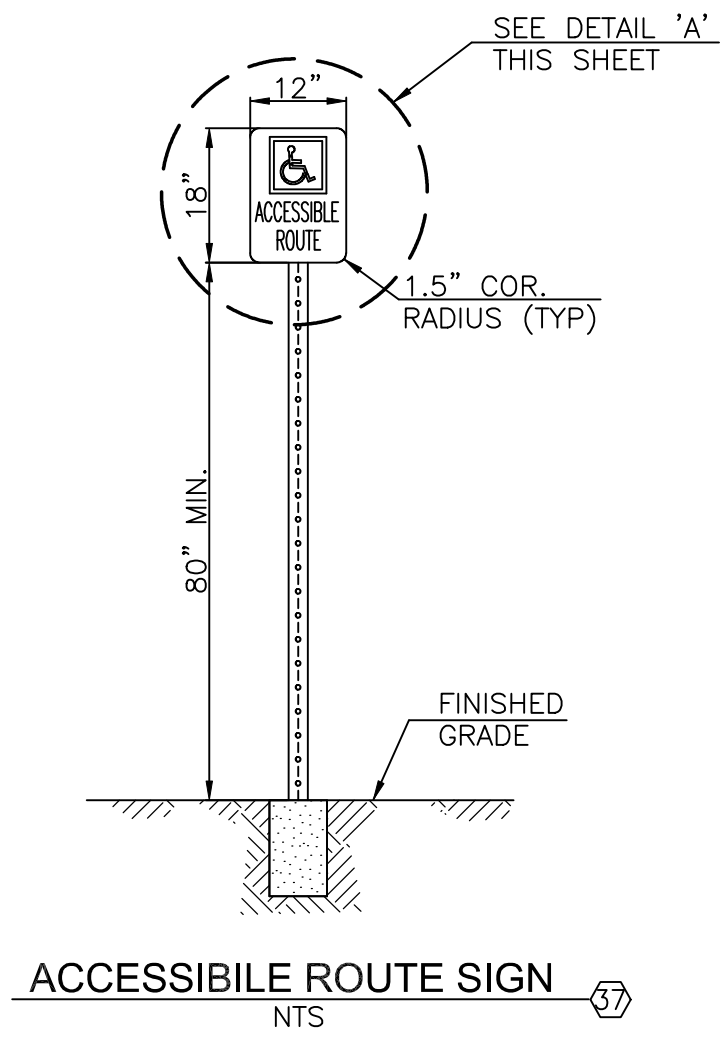

**ACCESSIBLE ROUTE SIGN**  
NTS



**DETAIL 'A'**  
**ACCESSIBLE ROUTE SIGN**  
NTS



DATE	BY	MARK	REVISIONS	APPR. DATE

DESIGNED BY: \_\_\_\_\_ ENGINEER  
DRAWN BY: \_\_\_\_\_ CITY  
CHECKED BY: \_\_\_\_\_

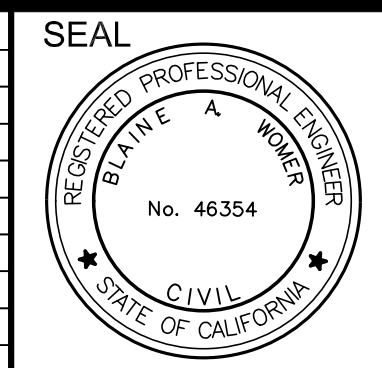

APPROVED BY: \_\_\_\_\_ DATE: \_\_\_\_\_

R.C.E. NO. \_\_\_\_\_ EXP. DATE \_\_\_\_\_

PREPARED BY: \_\_\_\_\_ DATE: \_\_\_\_\_

R.C.E. NO. \_\_\_\_\_ EXP. DATE \_\_\_\_\_

**B A W**

**BLAINE A. WOMER**  
CIVIL ENGINEERING

- PLANNING
- SURVEYING
- CIVIL ENGINEERING
- PUBLIC WORKS

Hermet, CA 92544, 41555 E. Florida Ave., Suite G, Phone (951)958-1727 Fax (951)958-9347  
Park City, UT 84096, 5133 Cove Canyon Dr., #302, Phone/Fax (435)815-1489

SCALE: \_\_\_\_\_ DATE: \_\_\_\_\_

BENCHMARK: \_\_\_\_\_

VALLEY WIDE RECREATION / PARK DISTRICT  
ACCESSIBILITY IMPROVEMENT PLAN  
PROJECT AREAS 5 & 6

FOR: \_\_\_\_\_ W.O.: \_\_\_\_\_



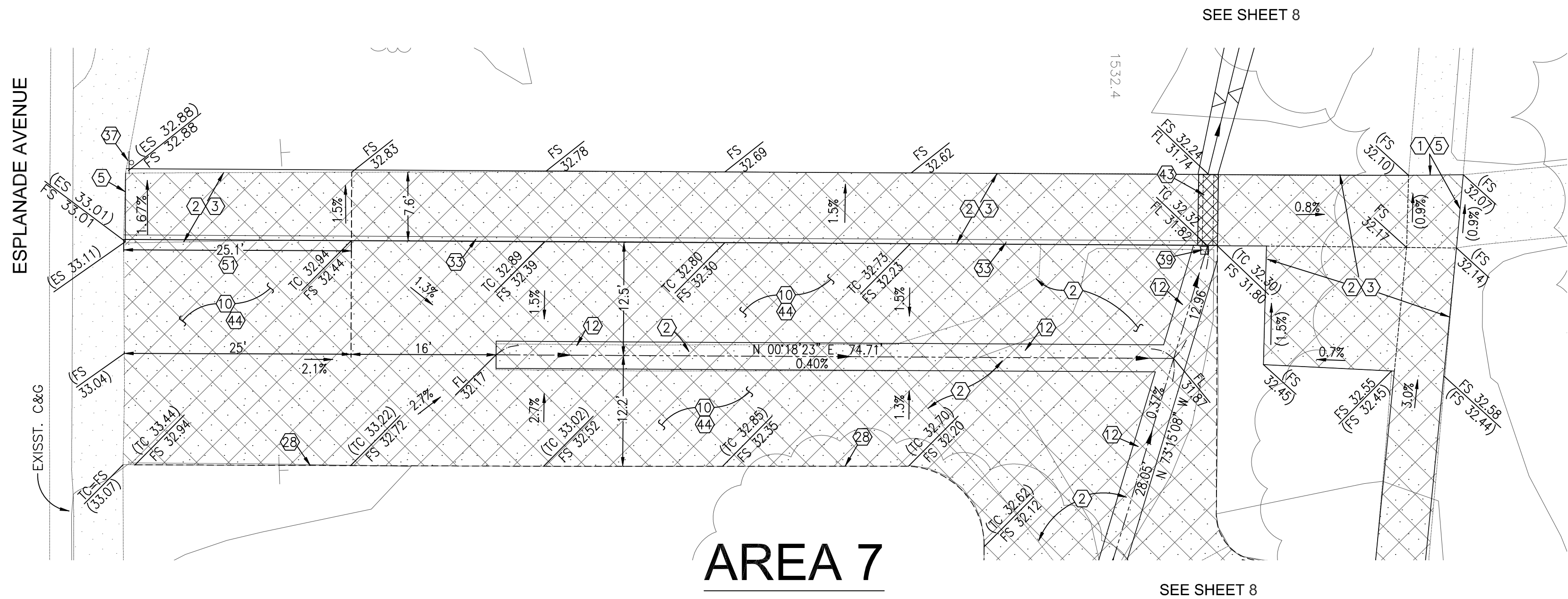
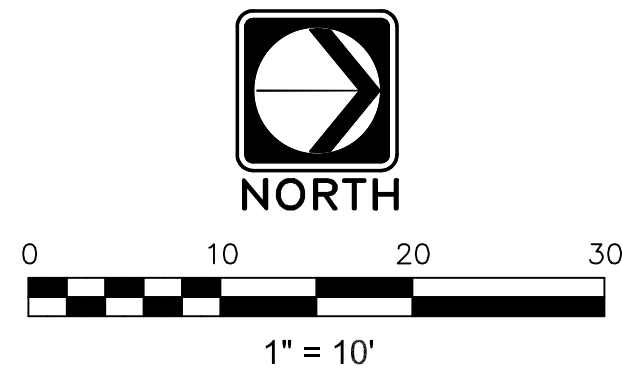

**CONSTRUCTION NOTES**

1. SAWCUT EXIST. CONCRETE.
2. REMOVE EXIST. CONCRETE.
3. CONSTRUCT 4" THICK CONCRETE WALKWAY PER RIV. CO. STD. NO. 401.
5. JOIN EXIST. SURFACE FLUSH.
8. REMOVE EXISTING CONCRETE CURB.
10. REMOVE EXIST. AC PAVEMENT.
12. CONSTRUCT 3.0" WIDE CONCRETE RIBBON GUTTER PER DETAIL SHEET 1.
13. REPLACE STRIPING DESTROYED BY PAVEMENT REMOVAL.
14. PAINT ADA PARKING SPACE STRIPING AND LEGEND PER 2019 CBC SECTION 11B-502.
15. INSTALL ADA PARKING SPACE SIGNAGE PER 2019 CBC SECTION 11B-502.6
18. PAINT "NO PARKING" IN 12" HIGH WHITE LETTERS.
21. INSTALL BROOKS PRODUCTS 36" LONG CONCRETE WHEEL STOP.
22. INSTALL CONCRETE STEP, HEIGHT AS SHOWN.
23. REMOVE EXISTING AC PAVEMENT RAMP.
24. GRIND AND OVERLAY EXISTING AC, MIN. 0.15'.
25. PROTECT IN PLACE EXISTING 4" DRAIN PIPE.
26. REMOVE EXISTING ADA PARKING SPACE SIGN.
27. CONSTRUCT ADA ACCESSIBLE RAMP PER RIV. CO. STD. 403, CASE 'B'.
28. PROTECT IN PLACE EXISTING CONCRETE CURB.
33. CONSTRUCT 6" TYPE D CURB PER RIV. CO. STD. NO. 204.
34. CONSTRUCT CONCRETE ACCESS RAMP.
35. INSTALL 3" HIGH WHEEL GUIDE & HAND RAIL PER 2019 CBC SEC. 11B-505 AND DETAILS SHEET 9.
37. INSTALL INTERNATIONAL SYMBOL OF ACCESSIBLE ROUTE SIGN PER 2019 CBC FIGURE 11B-703.7.2.1 AND DETAIL SHEET 4
39. REMOVE EXISTING BOX INLET.
43. CONSTRUCT UNDER SIDEWALK DRAIN PER RIV. CO. STD. NO. 309
44. CONSTRUCT 5.5" THICK FCC PAVEMENT. SECTION TO BE VERIFIED BY THE PROJECT GEOTECHNICAL ENGINEER.
51. CURB FACE TRANSITION, 6" TO 0".

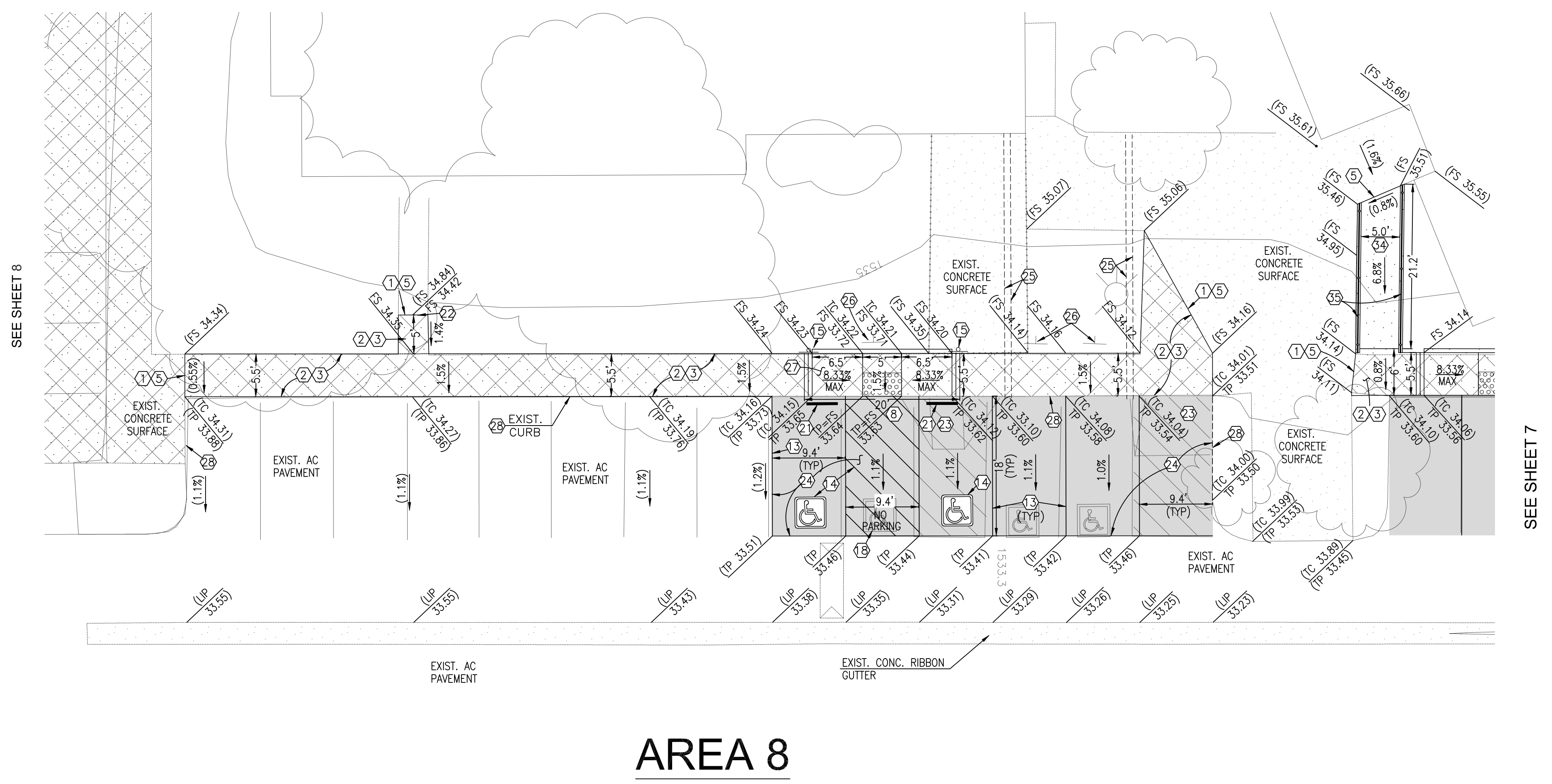

**AREA 8**



DATE	BY	MARK	REVISIONS	APPR. DATE
DESIGNED BY:			DRAWN BY:	CHECKED BY:

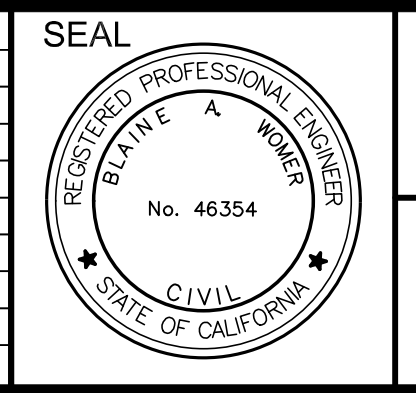

APPROVED BY: \_\_\_\_\_ DATE: \_\_\_\_\_

R.C.E. NO. \_\_\_\_\_ EXP. DATE \_\_\_\_\_

PREPARED BY: \_\_\_\_\_ DATE: \_\_\_\_\_

R.C.E. NO. \_\_\_\_\_ EXP. DATE \_\_\_\_\_

**B A W** **BLAINE A. WOMER**  
CIVIL ENGINEERING

PLANNING  
SURVEYING  
CIVIL ENGINEERING  
PUBLIC WORKS

SCALE: \_\_\_\_\_ DATE: \_\_\_\_\_

BENCHMARK: \_\_\_\_\_

VALLEY WIDE RECREATION / PARK DISTRICT  
**ACCESSIBILITY IMPROVEMENT PLAN**  
PROJECT AREAS 7 & 8

FOR: \_\_\_\_\_ W.O.: \_\_\_\_\_

SHEET NO. **5**  
OF 13 SHEETS  
FILE NO. \_\_\_\_\_

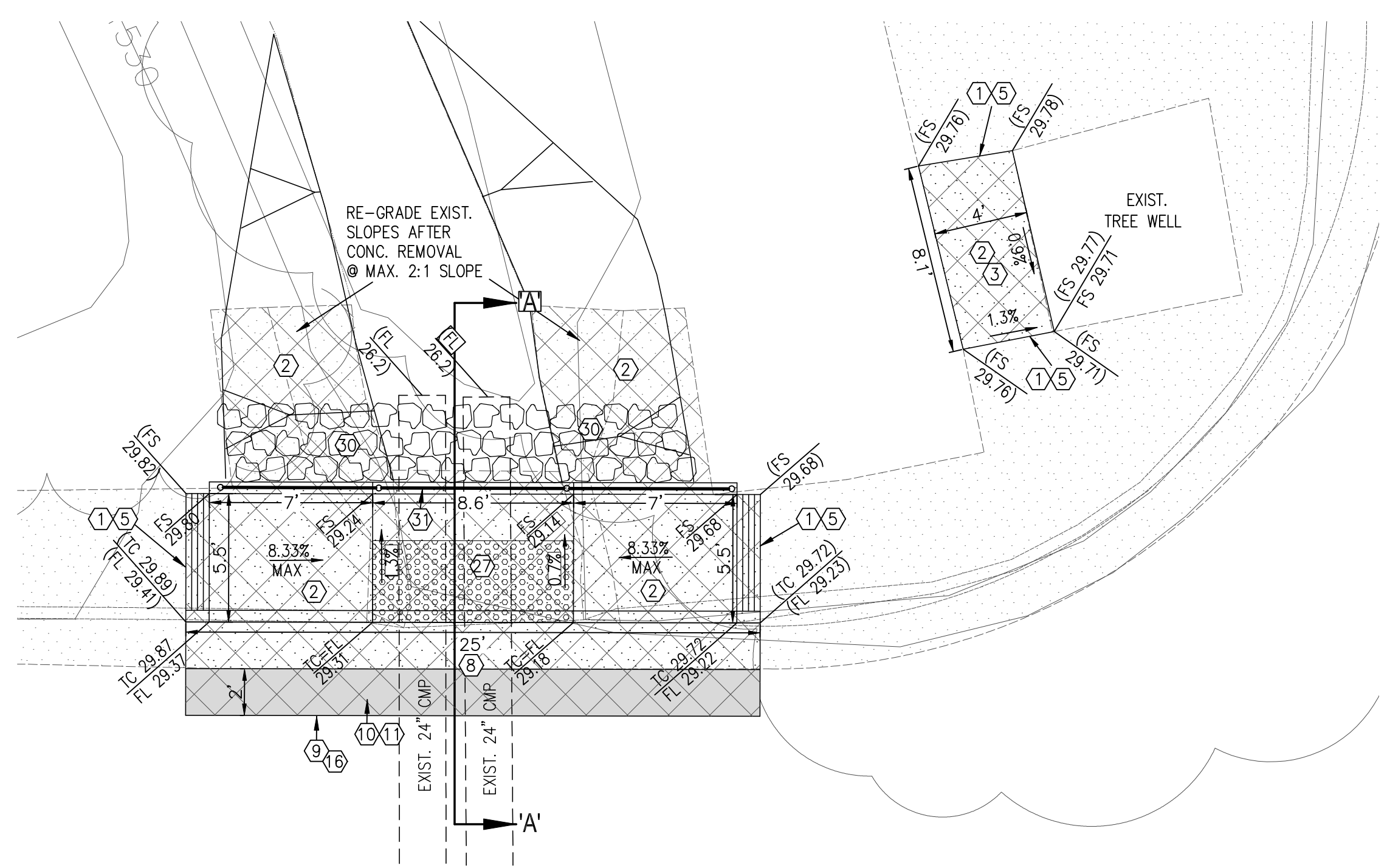
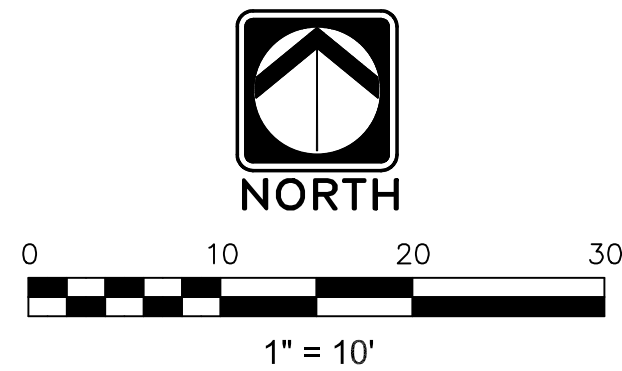

### AREA 9

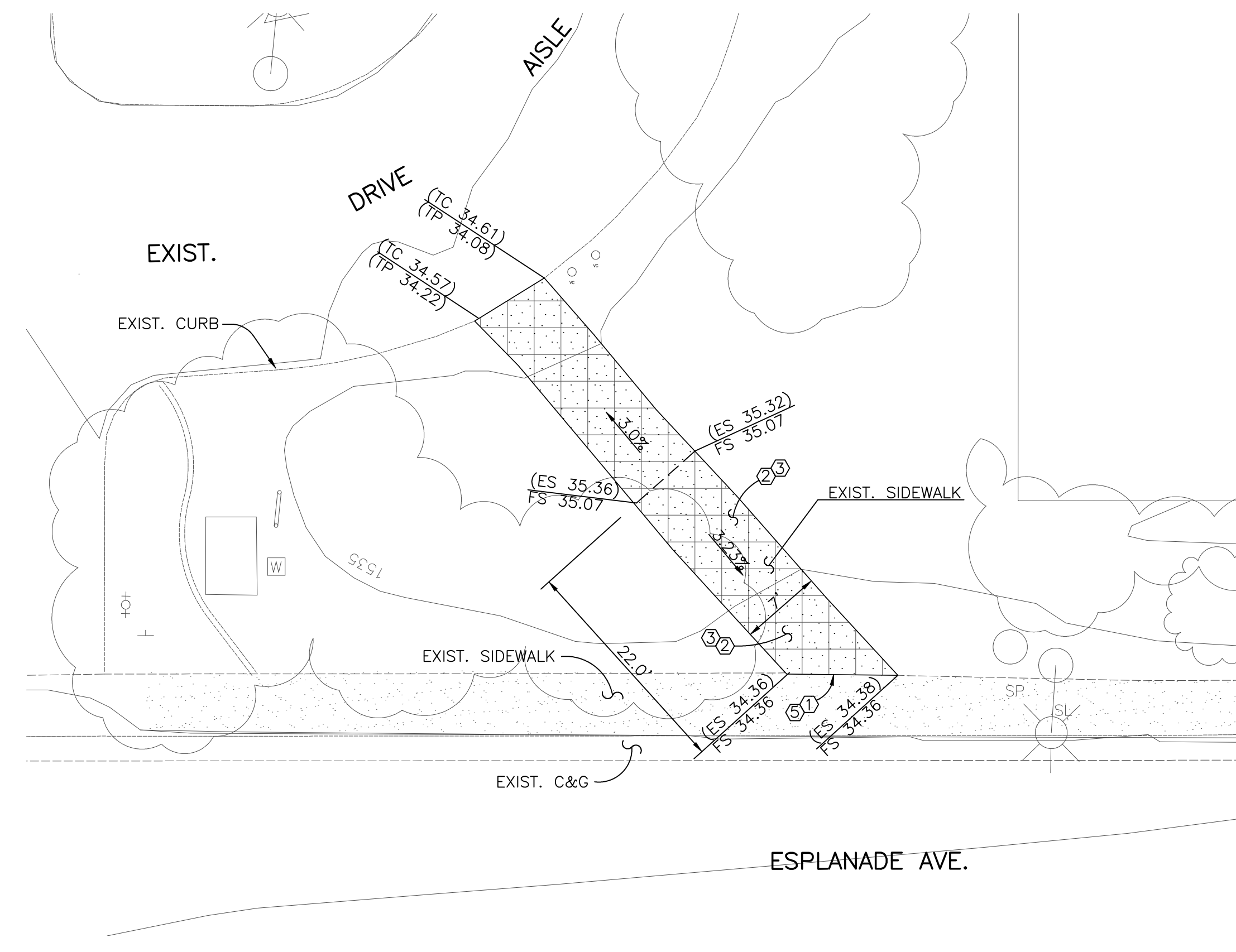

### AREA 11

- CONSTRUCTION NOTES**
1. SAWCUT EXIST. CONCRETE.
  2. REMOVE EXIST. CONCRETE.
  3. CONSTRUCT 4" THICK CONCRETE WALKWAY PER RIV. CO. STD. NO. 401.
  5. JOIN EXIST. SURFACE FLUSH.
  8. REMOVE EXISTING CONCRETE CURB.
  9. SAWCUT EXIST. AC PAVEMENT.
  10. REMOVE EXIST. AC PAVEMENT.
  11. INSTALL MIN. 3" AC OVER 4" CLASS II AGG. BASE.
  16. JOIN EXISTING AC PAVEMENT PER JOIN DETAIL SHEET 1.
  27. CONSTRUCT ADA ACCESSIBLE RAMP PER RIV. CO. STD. 403, CASE 'B'.
  29. INSTALL 6" THICK, 2.0' HIGH CUT OFF WALL.
  30. INSTALL RIP RAP, 50LB ROCK, MIN. 2" THICK.
  31. INSTALL HANDRAIL PER 2019 CBC, SEC. 11B-505.

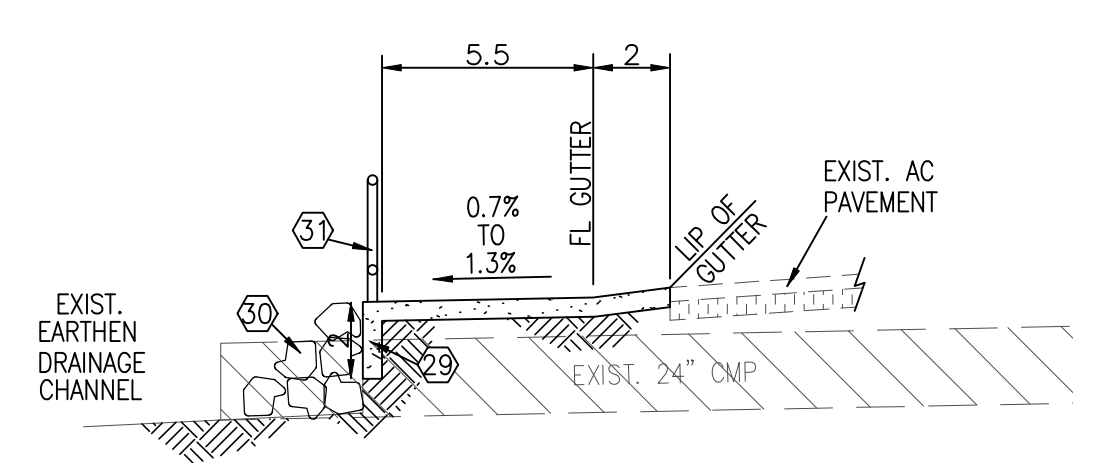

SECTION 'A'-'A'  
NTS

DATE	BY	MARK	REVISIONS	APPR. DATE
DESIGNED BY:	ENGINEER	MARK	DRAWN BY:	CHECKED BY:

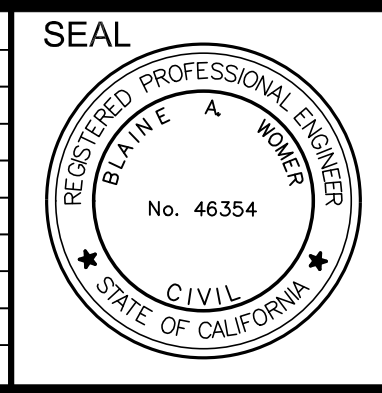

APPROVED BY: \_\_\_\_\_ DATE: \_\_\_\_\_

R.C.E. NO. \_\_\_\_\_ EXP. DATE \_\_\_\_\_

PREPARED BY: \_\_\_\_\_ DATE: \_\_\_\_\_

R.C.E. NO. \_\_\_\_\_ EXP. DATE \_\_\_\_\_

SCALE: \_\_\_\_\_

DATE: \_\_\_\_\_

BENCHMARK: \_\_\_\_\_

VALLEY WIDE RECREATION / PARK DISTRICT

ACCESSIBILITY IMPROVEMENT PLAN

PROJECT AREAS 9 & 11

FOR: \_\_\_\_\_ W.O.: \_\_\_\_\_

SHEET NO. **6**

OF 13 SHEETS

FILE NO. \_\_\_\_\_

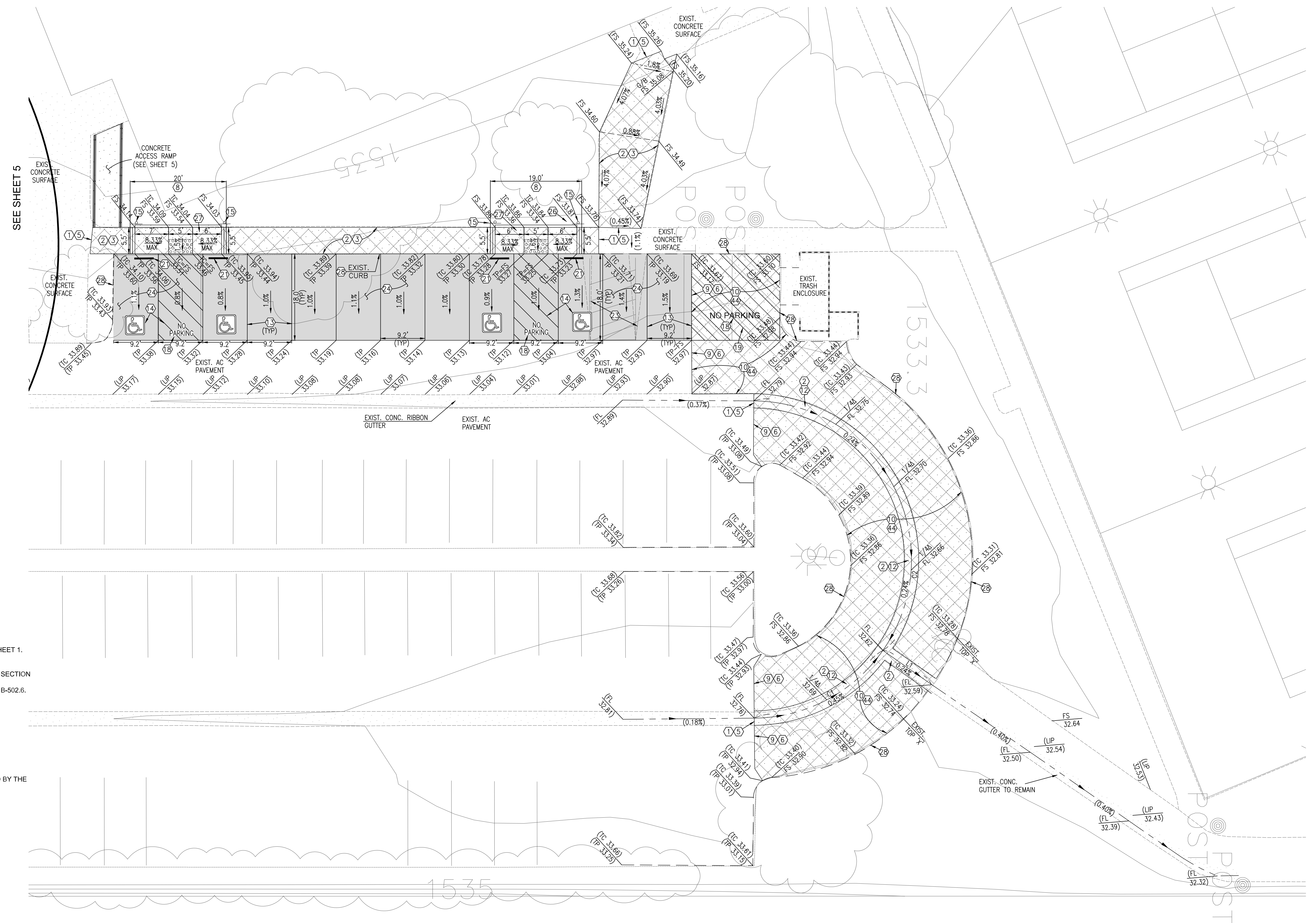
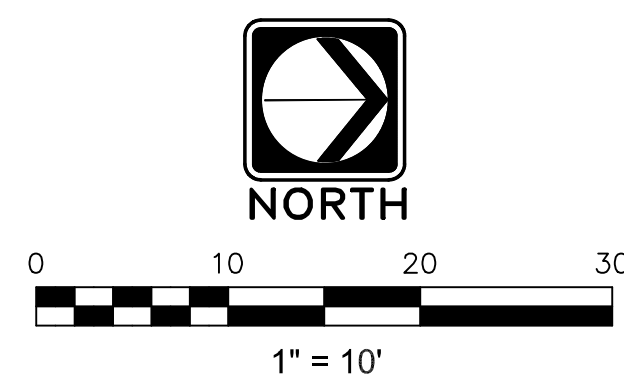

- CONSTRUCTION NOTES**
1. SAWCUT EXIST. CONCRETE.
  2. REMOVE EXIST. CONCRETE.
  3. CONSTRUCT 4" THICK CONCRETE WALKWAY PER RIV. CO. STD. NO. 401.
  5. JOIN EXIST. SURFACE FLUSH.
  6. SLURRY SEAL BETWEEN CONCRETE AND PAVEMENT.
  9. SAWCUT EXIST. AC PAVEMENT.
  10. REMOVE EXIST. AC PAVEMENT.
  12. CONSTRUCT 3.0' WIDE CONCRETE RIBBON GUTTER PER DETAIL SHEET 1.
  13. REPLACE STRIPING DESTROYED BY PAVEMENT REMOVAL.
  14. PAINT ADA PARKING SPACE STRIPING AND LEGEND PER 2019 CBC SECTION 11B-502.
  15. INSTALL ADA PARKING SPACE SIGNAGE PER 2019 CBC SECTION 11B-502.6.
  18. PAINT 'NO PARKING' IN 12" HIGH WHITE LETTERS.
  19. PAINT RED CROSS HATCH FOR NO PARKING AREA.
  21. INSTALL BROOKS PRODUCTS 36" LONG CONCRETE WHEEL STOP.
  23. REMOVE EXISTING AC PAVEMENT RAMP.
  24. GRIND AND OVERLAY EXISTING AC, MIN. 0.15'.
  27. CONSTRUCT ADA ACCESSIBLE RAMP PER RIV. CO. STD. 403, CASE 'B'.
  28. PROTECT IN PLACE EXISTING CONCRETE CURB.
  32. REMOVE AND REPLACE EXISTING PARKING LOT STRIPING AS SHOWN.
  44. CONSTRUCT 5.5" THICK PCC PAVEMENT. SECTION TO BE VERIFIED BY THE PROJECT GEOTECHNICAL ENGINEER.

**LINE DATA**

LINE	BEARING	DISTANCE
LT	N 35°01'01" E	12.26'

**CURVE DATA**

CURVE	RADIUS	LENGTH	DELTA	TANGENT
C1	33.00'	31.40'	54°31'03"	17.00'
C2	33.00'	35.89'	62°18'32"	19.95'

## AREA 12

<p><b>DIG ALERT</b> DIAL TOLL FREE 1-800-227-2600 <small>AT LEAST TWO DAYS BEFORE YOU DIG</small></p> <p style="font-size: 8px;">UNDERGROUND SERVICE ALERT OF SOUTHERN CALIFORNIA</p>	<table border="1" style="width: 100%; border-collapse: collapse;"> <thead> <tr> <th>DATE</th> <th>BY</th> <th>MARK</th> <th>REVISIONS</th> <th>APPR. DATE</th> </tr> </thead> <tbody> <tr> <td> </td> <td> </td> <td> </td> <td> </td> <td> </td> </tr> </tbody> </table>	DATE	BY	MARK	REVISIONS	APPR. DATE							APPROVED BY: _____ DATE: _____ R.C.E. NO. _____ EXP. DATE _____ PREPARED BY: _____ DATE: _____ R.C.E. NO. _____ EXP. DATE _____	<p><b>BLAINE A. WOMER</b> CIVIL ENGINEERING</p> <p style="font-size: 8px;">       • PLANNING        • SURVEYING        • CIVIL ENGINEERING        • PUBLIC WORKS     </p>	VALLEY WIDE RECREATION / PARK DISTRICT <b>ACCESSIBILITY IMPROVEMENT PLAN</b> <b>PROJECT AREA 12</b>	SHEET NO. <h1 style="font-size: 24px;">7</h1> OF 13 SHEETS FILE NO.
	DATE	BY	MARK	REVISIONS	APPR. DATE											
DESIGNED BY: _____ ENGINEER: _____	DRAWN BY: _____ REVISIONS: _____ CHECKED BY: _____	SCALE: _____ BENCHMARK: _____	FOR: _____ W.O.: _____													

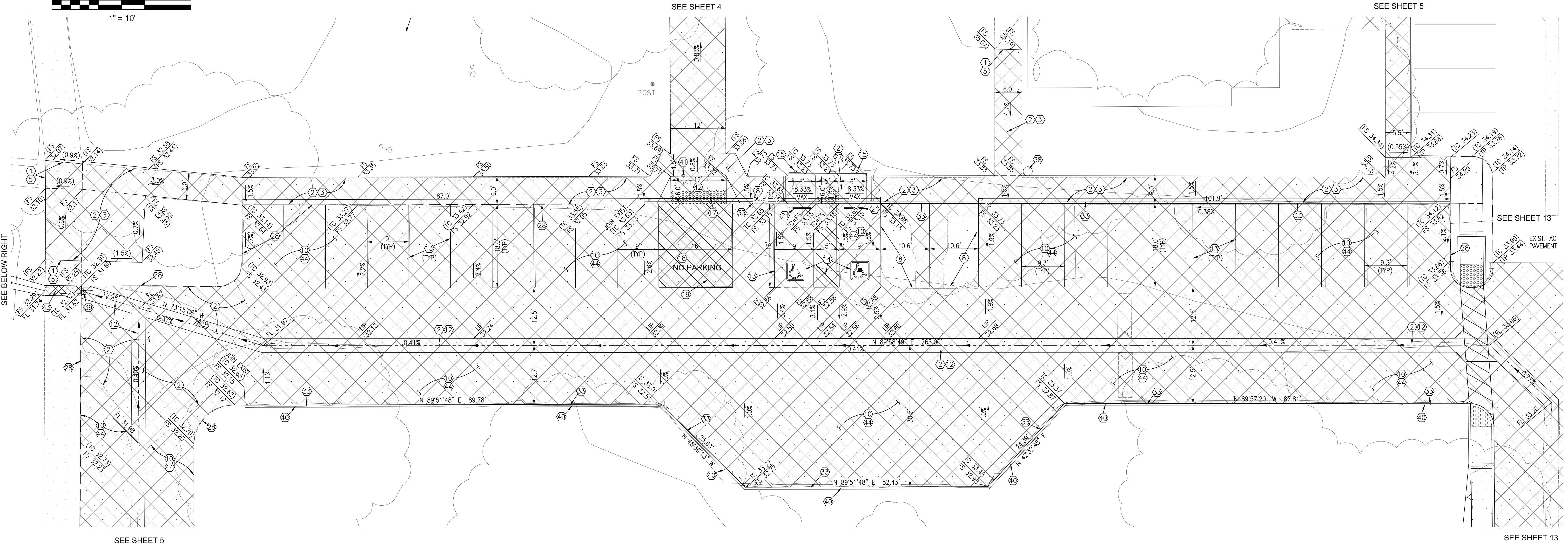
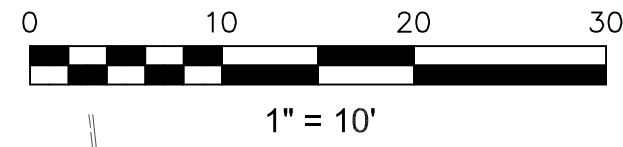

# AREA 13

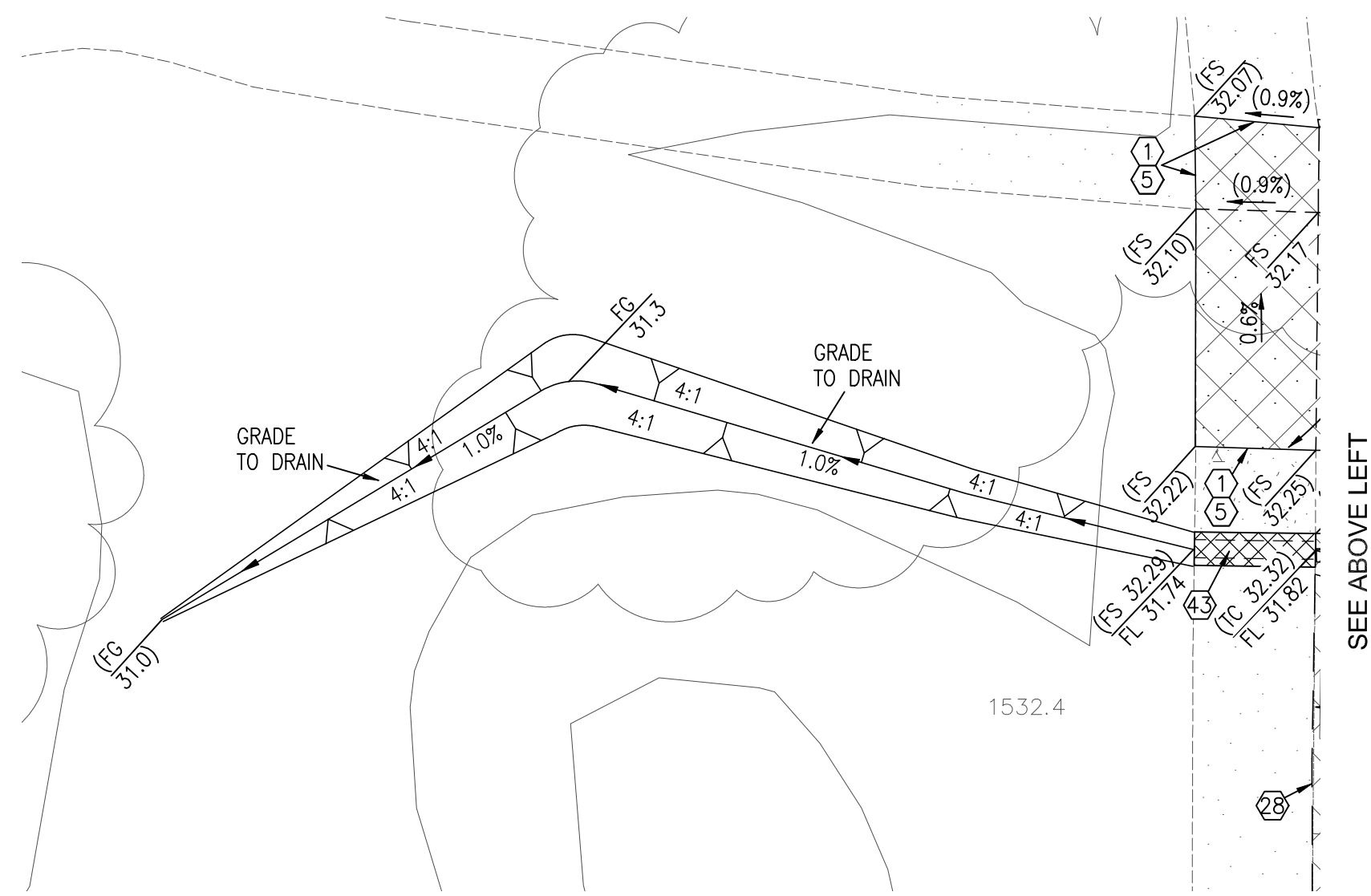

- CONSTRUCTION NOTES**
1. SAWCUT EXIST. CONCRETE.
  2. REMOVE EXIST. CONCRETE.
  3. CONSTRUCT 4" THICK CONCRETE WALKWAY PER RIV. CO. STD. NO. 401.
  5. JOIN EXIST. SURFACE FLUSH.
  8. REMOVE EXISTING CONCRETE CURB.
  10. REMOVE EXIST. AC PAVEMENT.
  12. CONSTRUCT 3.0' WIDE CONCRETE RIBBON GUTTER PER DETAIL SHEET 1.
  13. REPLACE STRIPING DESTROYED BY PAVEMENT REMOVAL.
  14. PAINT ADA PARKING SPACE STRIPING AND LEGEND PER 2019 CBC SECTION 11B-502.
  15. INSTALL ADA PARKING SPACE SIGNAGE PER 2019 CBC SECTION 11B-502.6.
  17. INSTALL TRUNCATED DOMES PER 2019 CBC SEC. 11B-705.
  18. PAINT 'NO PARKING' IN 12" HIGH WHITE LETTERS.
  19. PAINT RED CROSS HATCH FOR NO PARKING AREA.
  21. INSTALL BROOKS PRODUCTS 36" LONG CONCRETE WHEEL STOP.
  27. CONSTRUCT ADA ACCESSIBLE RAMP PER RIV. CO. STD. 403, CASE 'B'.
  28. PROTECT IN PLACE EXISTING CONCRETE CURB.
  33. CONSTRUCT 6" TYPE D CURB PER RIV. CO. STD. NO. 204.
  38. PROTECT IN PLACE EXISTING LIGHT STANDARD.
  39. REMOVE EXISTING BOX INLET.
  40. REMOVE EXISTING CONCRETE WHEEL STOPS.
  41. RELOCATE EXISTING BOLLARD BY DIRECTION OF OWNER.
  42. CONSTRUCT CONCRETE DRIVE APPROACH, 6" THICK, X=3'.
  43. CONSTRUCT UNDER SIDEWALK DRAIN PER RIV. CO. STD. NO. 309.
  44. CONSTRUCT 5.5" THICK FCC PAVEMENT. SECTION TO BE VERIFIED BY THE PROJECT GEOTECHNICAL ENGINEER.



DATE	BY	MARK	REVISIONS	APPR. DATE
DESIGNED BY:			DRAWN BY:	CHECKED BY:

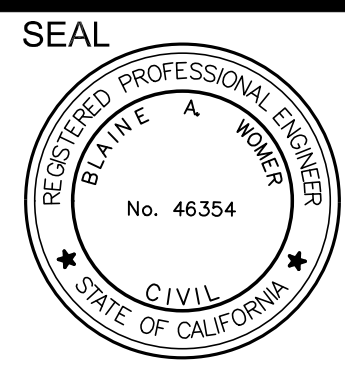

APPROVED BY: \_\_\_\_\_ DATE: \_\_\_\_\_  
 R.C.E. NO. \_\_\_\_\_ EXP. DATE \_\_\_\_\_  
 PREPARED BY: \_\_\_\_\_ DATE: \_\_\_\_\_  
 R.C.E. NO. \_\_\_\_\_ EXP. DATE \_\_\_\_\_

**B A W**  
**BLAINE A. WOMER**  
 CIVIL ENGINEERING

PLANNING  
 SURVEYING  
 CIVIL ENGINEERING  
 PUBLIC WORKS

Hemet, CA 92544, 41555 E. Florida Ave., Suite G, Phone (951)658-1727 Fax (951)658-9347  
 Park City, UT 84096, 5133 Cove Canyon Dr., #302, Phone/Fax (435)815-1489

SCALE: \_\_\_\_\_  
 BENCHMARK: \_\_\_\_\_  
 DATE: \_\_\_\_\_

VALLEY WIDE RECREATION / PARK DISTRICT  
 ACCESSIBILITY IMPROVEMENT PLAN  
 PROJECT AREA 13

FOR: \_\_\_\_\_ W.O.: \_\_\_\_\_

SHEET NO. **8** OF 13 SHEETS  
 FILE NO. \_\_\_\_\_



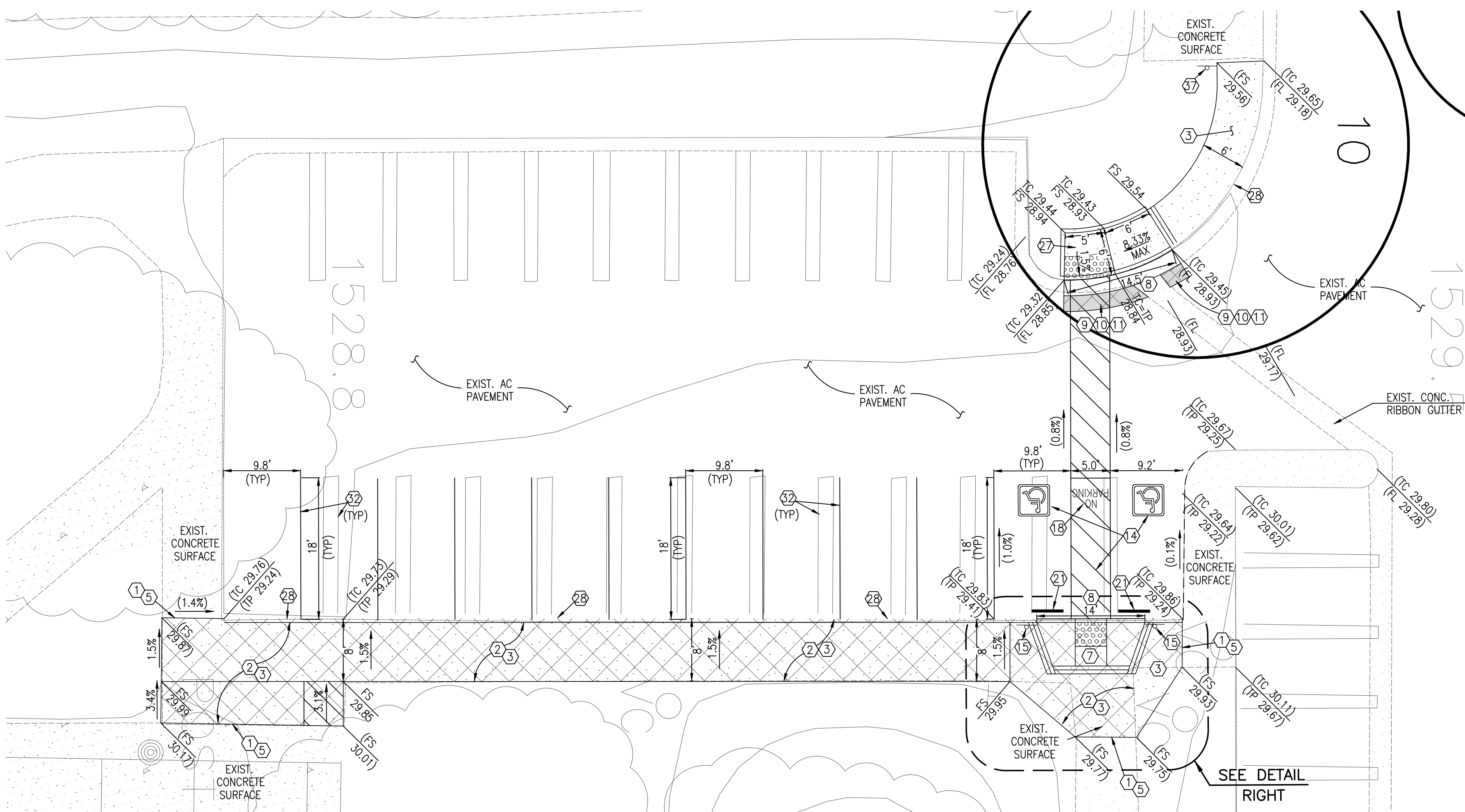
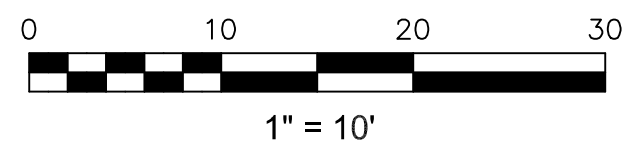

**CONSTRUCTION NOTES**

1. SAWCUT EXIST. CONCRETE.
2. REMOVE EXIST. CONCRETE.
3. CONSTRUCT 4" THICK CONCRETE WALKWAY PER RIV. CO. STD. 401.
5. JOIN EXIST. SURFACE FLUSH.
7. CONSTRUCT ADA ACCESSIBLE RAMP PER RIV. CO. STD. 403, CASE 'A'.
8. REMOVE EXISTING CONCRETE CURB.
9. SAWCUT EXIST. AC PAVEMENT.
10. REMOVE EXIST. AC PAVEMENT.
11. INSTALL MIN. 3" AC OVER 4" CLASS II AGG. BASE.
14. PAINT ADA PARKING SPACE STRIPING AND LEGEND PER 2019 CBC SECTION 11B-502.
15. INSTALL ADA PARKING SPACE SIGNAGE PER 2019 CBC SECTION 11B-502.6.
18. PAINT 'NO PARKING' IN 12" HIGH WHITE LETTERS.
21. INSTALL BROOKS PRODUCTS 36" LONG CONCRETE WHEEL STOP.
27. CONSTRUCT ADA ACCESSIBLE RAMP PER RIV. CO. STD. 403, CASE 'B'.
28. PROTECT IN PLACE EXISTING CONCRETE CURB.
32. REMOVE AND REPLACE EXISTING PARKING LOT STRIPING AS SHOWN.
37. INSTALL INTERNATIONAL SYMBOL OF ACCESSIBLE ROUTE SIGN PER 2019 CBC FIGURE 11B-703.7.2.1 AND DETAIL SHEET 4.

**AREA 10**

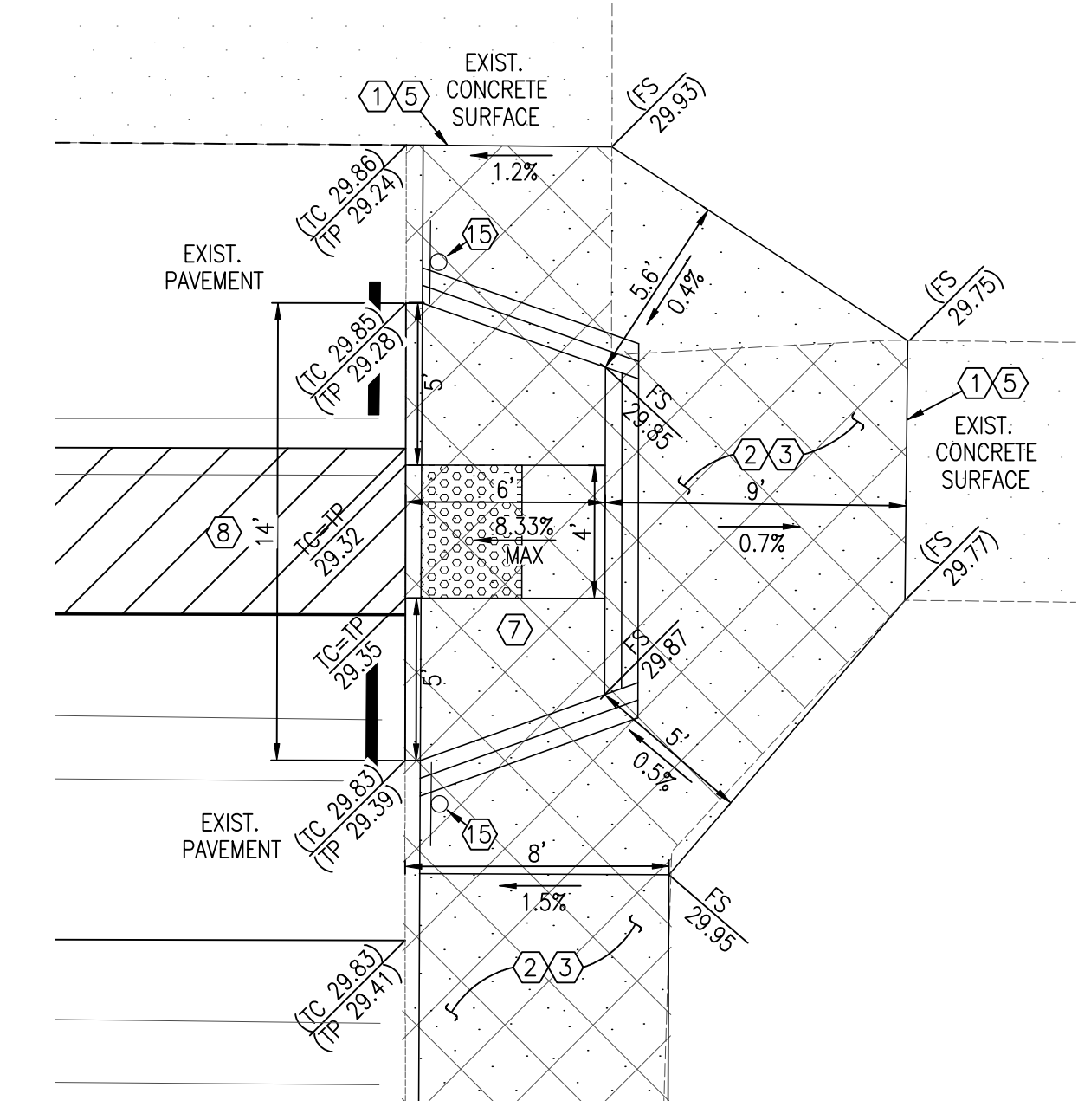

DETAIL  
1"=5'



**DIG ALERT**  
DIAL TOLL FREE  
1-800-227-2600  
AT LEAST TWO DAYS BEFORE YOU DIG  
UNDERGROUND SERVICE ALERT OF SOUTHERN CALIFORNIA

DATE	BY	MARK	REVISIONS	APPR. DATE

DESIGNED BY: \_\_\_\_\_ DRAWN BY: \_\_\_\_\_ CHECKED BY: \_\_\_\_\_



APPROVED BY: \_\_\_\_\_ DATE: \_\_\_\_\_

R.C.E. NO. \_\_\_\_\_ EXP. DATE \_\_\_\_\_

PREPARED BY: \_\_\_\_\_ DATE: \_\_\_\_\_

R.C.E. NO. \_\_\_\_\_ EXP. DATE \_\_\_\_\_

**B A W**  
**BLAINE A. WOMER**  
CIVIL ENGINEERING

• PLANNING  
• SURVEYING  
• CIVIL ENGINEERING  
• PUBLIC WORKS

Hermet, CA 92544, 41555 E. Florida Ave., Suite G, Phone (951)958-1727 Fax (951)958-9347  
Park City, UT 84096, 5133 Cove Canyon Dr., #302, Phone/Fax (435)815-1489

SCALE: \_\_\_\_\_ DATE: \_\_\_\_\_

BENCHMARK: \_\_\_\_\_

VALLEY WIDE RECREATION / PARK DISTRICT  
ACCESSIBILITY IMPROVEMENT PLAN  
PROJECT AREA 10

FOR: \_\_\_\_\_ W.O.: \_\_\_\_\_

SHEET NO.  
**10**  
OF 13 SHEETS  
FILE NO.

- CONSTRUCTION NOTES**
3. CONSTRUCT 4" THICK CONCRETE WALKWAY PER RIV. CO. STD.
  5. JOIN EXIST. SURFACE FLUSH.

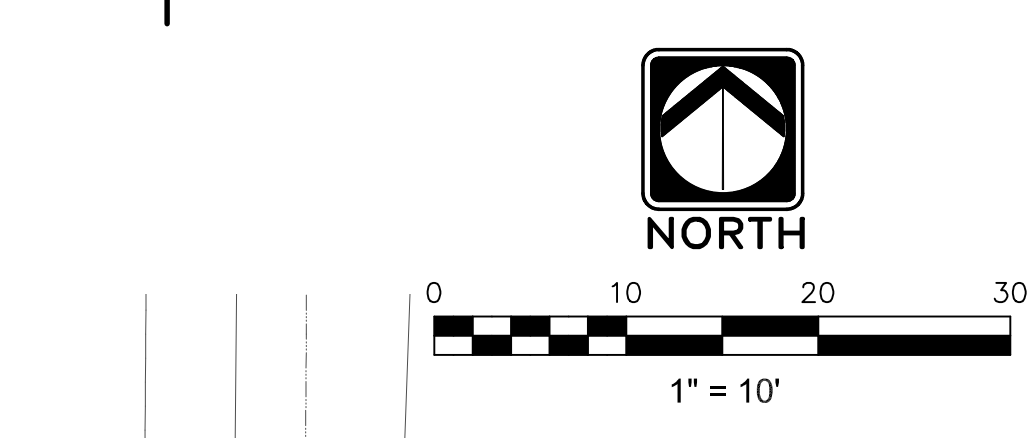
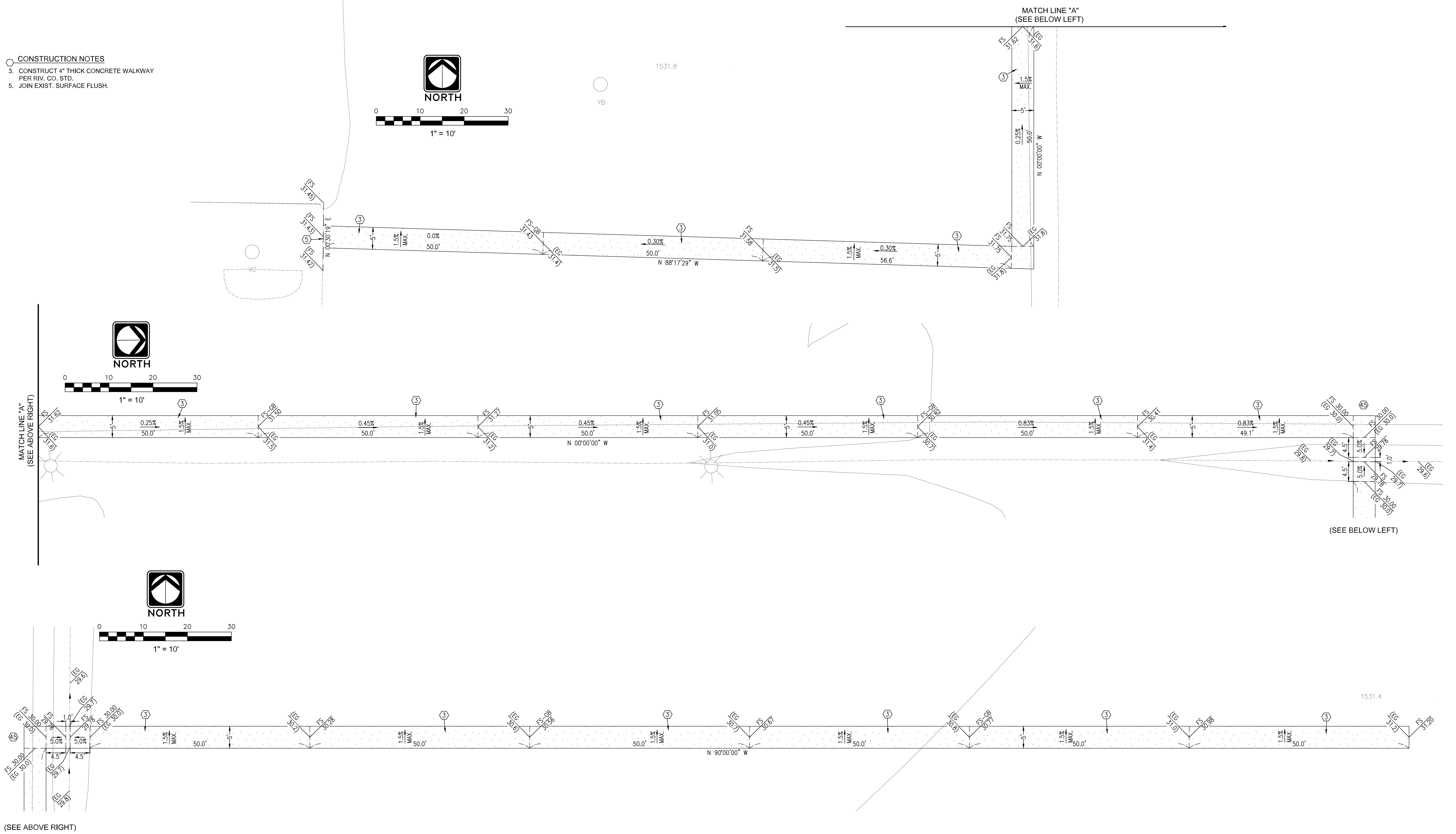
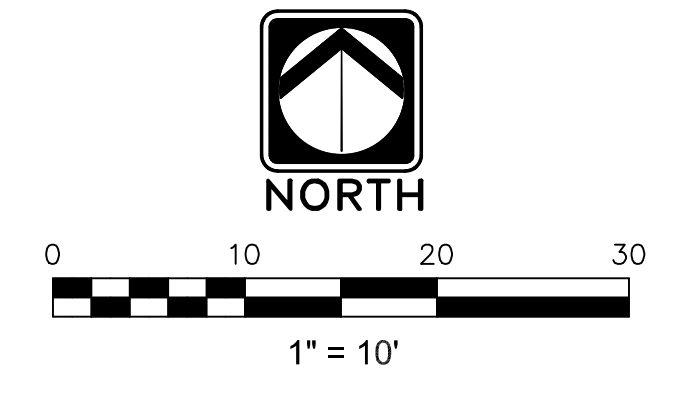

**DIG ALERT**  
DIAL TOLL FREE  
1-800-227-2600  
AT LEAST TWO DAYS BEFORE YOU DIG  
UNDERGROUND SERVICE ALERT OF SOUTHERN CALIFORNIA

DATE	BY	MARK	REVISIONS	APPR. DATE

DESIGNED BY: \_\_\_\_\_ ENGINEER  
DRAWN BY: \_\_\_\_\_ DRAWN BY  
CHECKED BY: \_\_\_\_\_ CHECKED BY

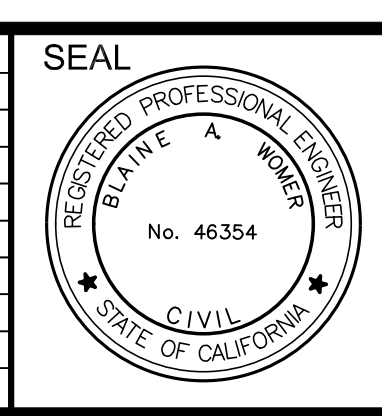

APPROVED BY: \_\_\_\_\_ DATE \_\_\_\_\_  
CITY ENGINEER

R.C.E. NO. \_\_\_\_\_ EXP. DATE \_\_\_\_\_

PREPARED BY: \_\_\_\_\_ DATE \_\_\_\_\_

R.C.E. NO. \_\_\_\_\_ EXP. DATE \_\_\_\_\_

**BLAINE A. WOMER**  
CIVIL ENGINEERING

• PLANNING  
• SURVEYING  
• CIVIL ENGINEERING  
• PUBLIC WORKS

SCALE: \_\_\_\_\_  
DATE: \_\_\_\_\_

BENCHMARK: \_\_\_\_\_

VALLEY WIDE RECREATION / PARK DISTRICT  
ACCESSIBILITY IMPROVEMENT PLAN  
PROJECT AREA 15

FOR: \_\_\_\_\_ W.O.: \_\_\_\_\_

SHEET NO. **11**  
OF 13 SHEETS  
FILE NO. \_\_\_\_\_

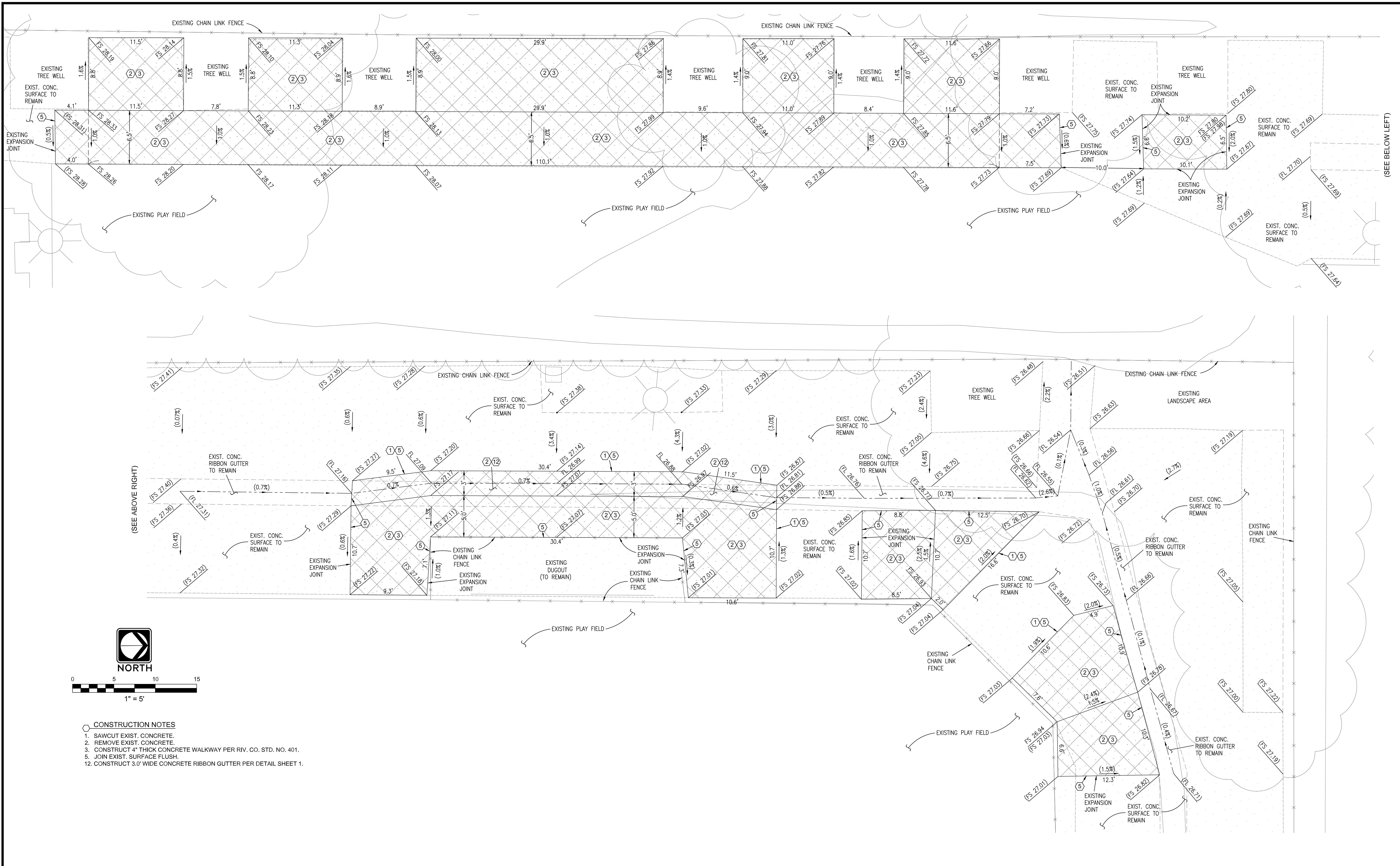

(SEE ABOVE RIGHT)

(SEE BELOW LEFT)

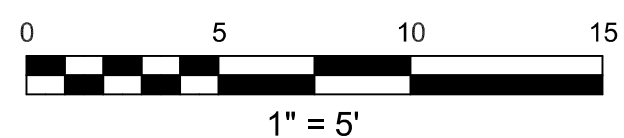

- CONSTRUCTION NOTES**
1. SAWCUT EXIST. CONCRETE.
  2. REMOVE EXIST. CONCRETE.
  3. CONSTRUCT 4" THICK CONCRETE WALKWAY PER RIV. CO. STD. NO. 401.
  5. JOIN EXIST. SURFACE FLUSH.
  12. CONSTRUCT 3.0' WIDE CONCRETE RIBBON GUTTER PER DETAIL SHEET 1.

**DIG ALERT**  
 DIAL TOLL FREE  
 1-800-227-2600  
 AT LEAST TWO DAYS  
 BEFORE YOU DIG  
 UNDERGROUND SERVICE ALERT OF SOUTHERN CALIFORNIA

DATE	BY	MARK	REVISIONS	APPR. DATE
DESIGNED BY:			DRAWN BY:	CHECKED BY:

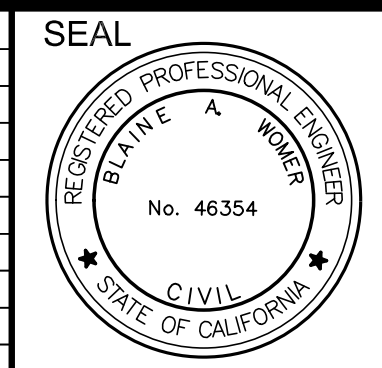

APPROVED BY: \_\_\_\_\_ DATE \_\_\_\_\_  
 CITY ENGINEER  
 R.C.E. NO. \_\_\_\_\_ EXP. DATE \_\_\_\_\_  
 PREPARED BY: \_\_\_\_\_ DATE \_\_\_\_\_  
 R.C.E. NO. \_\_\_\_\_ EXP. DATE \_\_\_\_\_

**B A W**  
 BLAINE A. WOMER  
 CIVIL ENGINEERING  
 PLANNING  
 SURVEYING  
 CIVIL ENGINEERING  
 PUBLIC WORKS

SCALE: \_\_\_\_\_  
 DATE: \_\_\_\_\_  
 BENCHMARK: \_\_\_\_\_

VALLEY WIDE RECREATION / PARK DISTRICT  
 ACCESSIBILITY IMPROVEMENT PLAN  
 PROJECT AREA 16

FOR: \_\_\_\_\_ W.O.: \_\_\_\_\_

SHEET NO. **12**  
 OF 13 SHEETS  
 FILE NO. \_\_\_\_\_



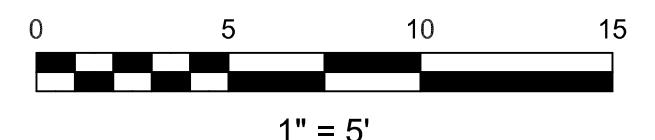
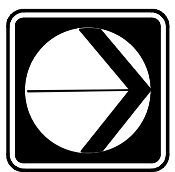

- CONSTRUCTION NOTES**
1. SAWCUT EXIST. CONCRETE.
  2. REMOVE EXIST. CONCRETE.
  3. CONSTRUCT 4" THICK CONCRETE WALKWAY PER RIV. CO. STD. NO. 401.
  4. ADA ACCESSIBLE PARKING LOT STRIPING PER CBC 2019 SEC. 11B-502 FIG. 11B-502.2, 11B-502.3 & 11B-502.3.3.
  5. JOIN EXIST. SURFACE FLUSH.
  6. SLURRY SEAL BETWEEN CONCRETE AND PAVEMENT.
  8. REMOVE EXISTING CONCRETE CURB.
  9. SAWCUT EXIST. AC PAVEMENT.
  10. REMOVE EXIST. AC PAVEMENT.
  12. CONSTRUCT 3.0" WIDE CONCRETE RIBBON GUTTER PER DETAIL SHEET 1.
  13. REPLACE STRIPING DESTROYED BY PAVEMENT REMOVAL.
  17. INSTALL TRUNCATED DOMES PER 2019 CBC SEC. 11B-705.
  28. PROTECT IN PLACE EXISTING CONCRETE CURB.
  33. CONSTRUCT 6" TYPE D CURB PER RIV. CO. STD. NO. 204.
  34. CONSTRUCT CONCRETE ACCESS RAMP.
  37. INSTALL INTERNATIONAL SYMBOL OF ACCESSIBLE ROUTE SIGN PER 2019 CBC FIGURE 11B-703.7.2.1 AND DETAIL SHEET 4.
  44. CONSTRUCT 5.5" THICK PCC PAVEMENT. SECTION TO BE VERIFIED BY THE PROJECT GEOTECHNICAL ENGINEER.
  45. CONSTRUCT COMMERCIAL DRIVEWAY PER RIV. CO. STD. NO. 207A.
  46. REMOVE EXISTING TREE, DIA. AS SHOWN.
  47. RELOCATE EXISTING UTILITY BOX.
  48. RELOCATE EXISTING PARKING LOT SIGN BEHIND PROPOSED SIDEWALK.
  49. PROTECT IN PLACE EXISTING 4" BLOW OFF.
  50. CONSTRUCT 8.0" WIDE CONCRETE RIBBON GUTTER PER DETAIL SHEET 1.
  51. CURB FACE TRANSITION, 6" TO 0".

**LINE DATA**

LINE	BEARING	DISTANCE
L1	N 00°14'56" W	1.65'
L2	N 89°27'53" E	1.19'
L3	N 00°32'07" W	1.28'

**CURVE DATA**

CURVE	RADIUS	LENGTH	DELTA	TANGENT
C1	15.00'	23.58'	90°03'27"	15.02'
C2	15.00'	23.74'	90°41'02"	15.18'
C3	6.50'	9.70'	85°31'10"	6.01'
C4	5.00'	7.81'	89°29'47"	4.96'
C5	4.00'	6.30'	90°17'11"	4.02'
C6	4.00'	6.28'	90°00'00"	4.00'

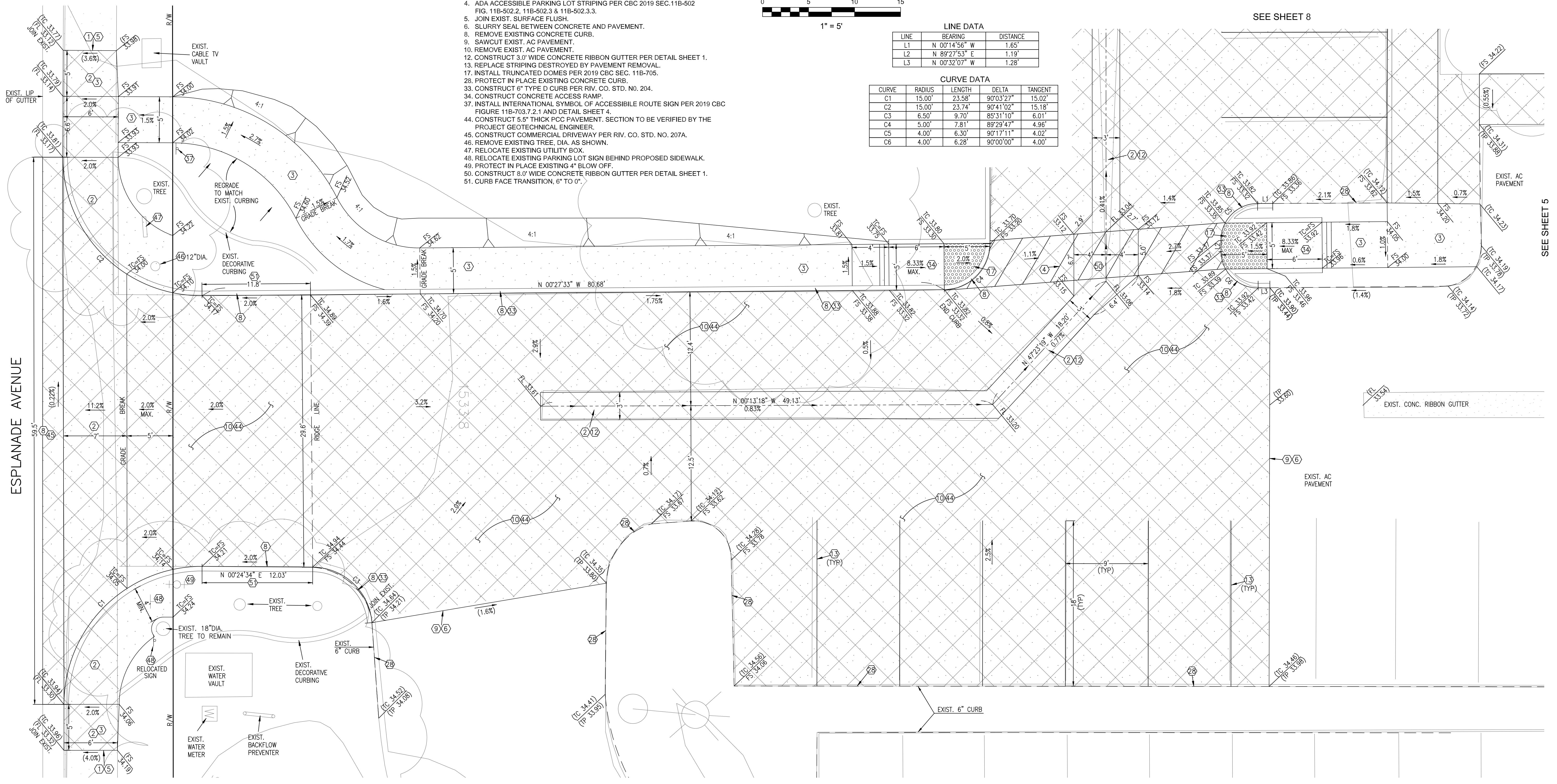

SEE SHEET 8

SEE SHEET 5

# AREA 17



DATE	BY	MARK	REVISIONS	APPR. DATE
DESIGNED BY:	ENGINEER	DRAWN BY:	CHECKED BY:	CITY

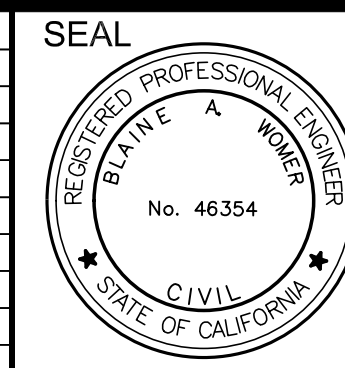

APPROVED BY: \_\_\_\_\_ DATE \_\_\_\_\_

CITY ENGINEER

R.C.E. NO. \_\_\_\_\_ EXP. DATE \_\_\_\_\_

PREPARED BY: \_\_\_\_\_ DATE \_\_\_\_\_

R.C.E. NO. \_\_\_\_\_ EXP. DATE \_\_\_\_\_

**BAW** BLAINE A. WOMER  
CIVIL ENGINEERING

PLANNING  
SURVEYING  
CIVIL ENGINEERING  
PUBLIC WORKS

SCALE \_\_\_\_\_ BENCHMARK: \_\_\_\_\_

VALLEY WIDE RECREATION / PARK DISTRICT  
ACCESSIBILITY IMPROVEMENT PLAN  
PROJECT AREA 17

SHEET NO. **13**  
OF 13 SHEETS  
FILE NO. \_\_\_\_\_

FOR \_\_\_\_\_ W.O. \_\_\_\_\_

## “Additional R/R Concrete Exhibit”



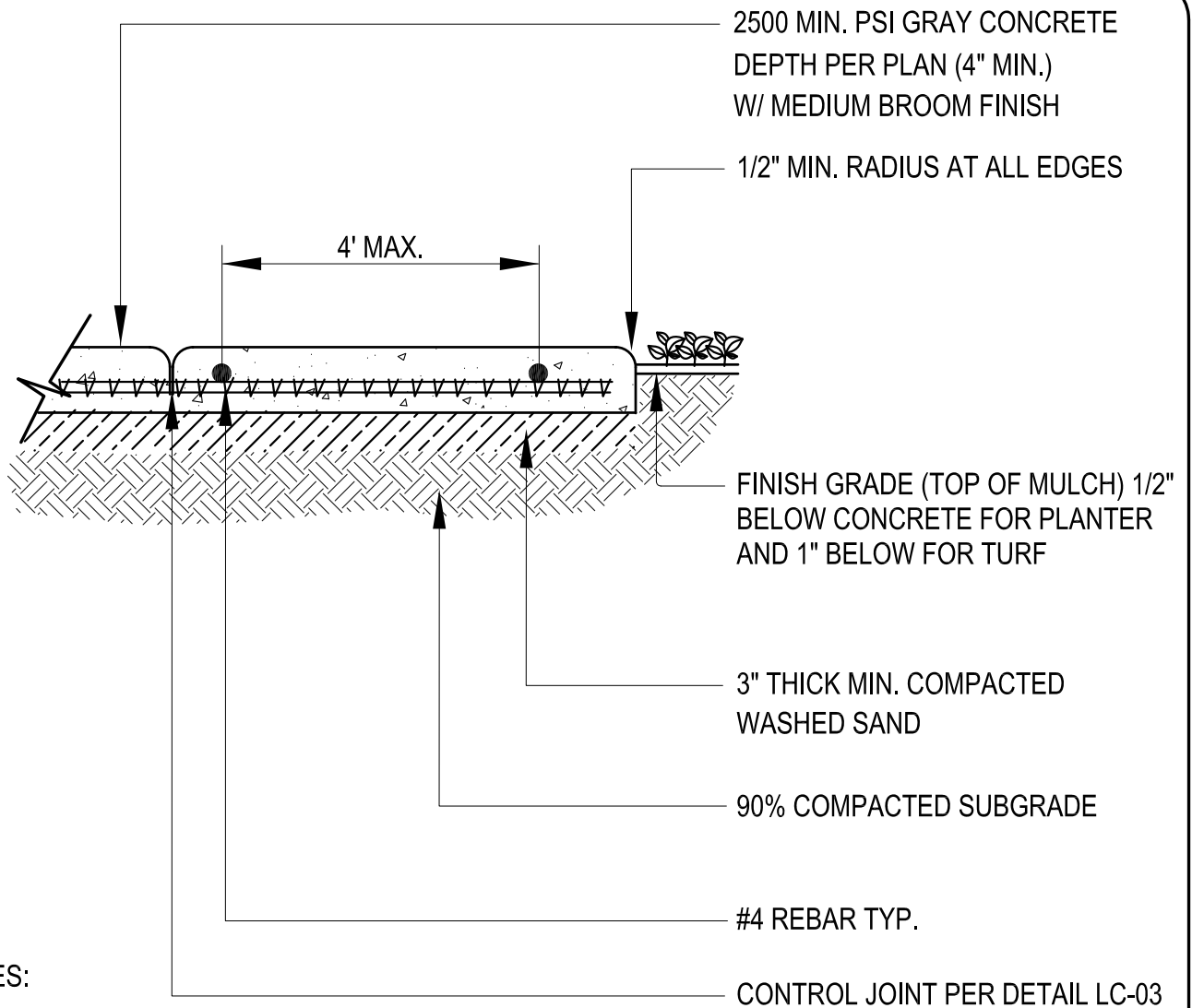

NOTES:

- CONCRETE CROSS SLOPE SHALL NOT BE GREATER THAN 2%
- CONCRETE LONGITUDINAL SLOPE SHALL NOT BE GREATER THAN 5% WITHOUT HANDRAILS
- CONCRETE SHALL NOT BE FLATTER THAN 0.5% TO AVOID PONDING
- PROVIDE 3/8" FELT EXPANSION JOINTS WHEN CONCRETE JOINS WITH A BLOCK WALL OR OTHER STRUCTURE
- ALL CONCRETE MUST COMPLY WITH ADA REGULATIONS
- PROVIDE #4 REBAR AT 4' SQUARE SPACING (2 CONTINUOUS ALONG SIDEWALKS)
- ALL CONCRETE FORMS MUST BE INSPECTED PRIOR TO POURING
- ALL CONCRETE AND SUBGRADES SHALL COMPLY WITH SOILS REPORT
- REFER TO ADDITIONAL REQUIREMENTS ON DETAIL LC-03

LD Consulting 2012 (Any deviation or reproduction of this design must be approved in writing by Valley-Wide Recreation & Park District)



VALLEY-WIDE RECREATION & PARK DISTRICT

CONCRETE FLATWORK

LC-02

REV. 2012

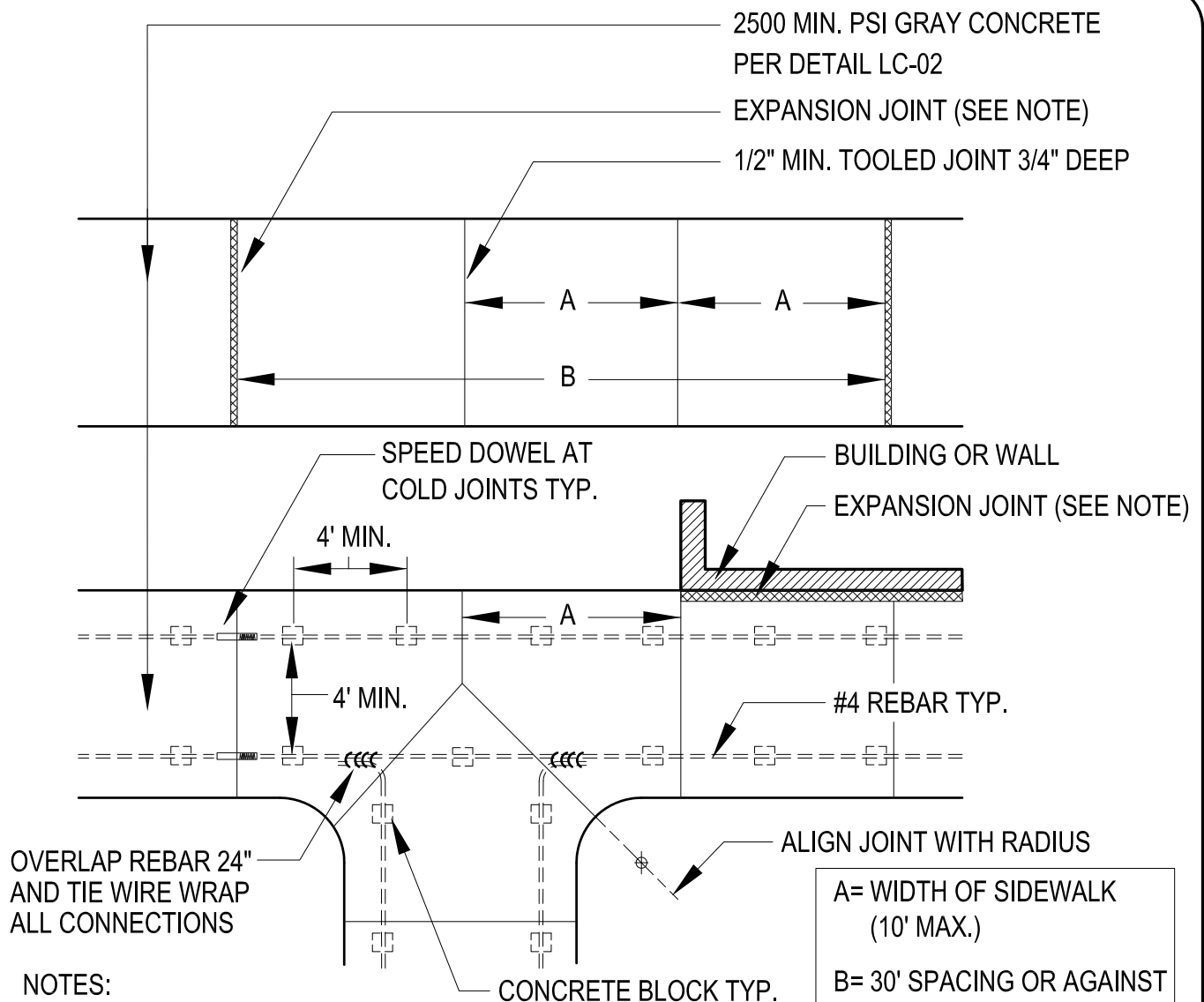

- NOTES:
- ALL JOINTS SHALL BE PERPENDICULAR TO CONCRETE EDGE
  - ALL JOINTS SHALL BE HAND TOOLED AND SAWCUT TO A DEPTH OF 1-1/2"
  - SAW CUTTING IN LIEU OF TOOLED JOINT MUST BE APPROVED IN WRITING BY THE DISTRICT
  - PROVIDE 3/8" FELT EXPANSION JOINTS WHEN CONCRETE JOINS WITH WALL OR BUILDING
  - PROVIDE 3/8" FELT EXPANSION JOINTS AT 30 FOOT SPACING TYP.
  - PROVIDE ALL RAMP JOINT TOOLING PER ADA STANDARDS
  - SPEED DOWELS SHALL BE USED BETWEEN EACH COLD JOINT POURS
  - ALL REBAR MUST BE 2" FROM ANY EDGE OF CONCRETE AND BE SECURED TO A 2"X2" MINIMUM CONCRETE BLOCK AT 4' O.C. MINIMUM SPACING PER SPECS.
  - DRILL AND SECURE REBAR WITH EPOXY AGAINST ALL EXISTING COLD JOINTS WITH SPEED DOWELS

LD Consulting 2012 (Any deviation or reproduction of this design must be approved in writing by Valley-Wide Recreation & Park District)



# VALLEY-WIDE RECREATION & PARK DISTRICT

## CONCRETE REBAR AND JOINTS

LC-03  
REV. 2012